

JVC®

ENGLISH

DIGITAL VIDEO CAMERA

GR-DV2000

Please visit our Homepage on the World Wide Web and answer our Consumer Survey (in English only):

<http://www.jvc-victor.co.jp/english/index-e.html>

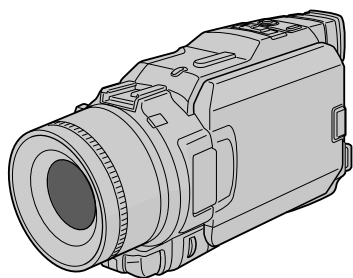

Mini **DV** PAL
DSC
DIGITAL
STILL CAMERA

INSTRUCTIONS

CONTENTS

AUTOMATIC DEMONSTRATION 5

GETTING STARTED 6 – 15

RECORDING 16 – 37

Basic Recording For Video 16

Basic Recording For Digital Still Camera
(D.S.C.) 19

Basic Recording For Video And D.S.C. 20

Advanced Features For Video And D.S.C. 22

PLAYBACK 38 – 51

Basic Playback For Video 38

Advanced Features For Video 39

Basic Playback For D.S.C. 42

Advanced Features For D.S.C. 44

CONNECTIONS 52 – 55

Basic Connections 52

Advanced Connections 54

DUBBING 56 – 60

Dubbing To A VCR 56

Dubbing From A VCR 57

Dubbing To A Video Unit
Equipped With A DV Connector 58

Dubbing From A Video Unit
Equipped With A DV Connector 59

Dubbing Images Recorded
On A Tape To A Memory Card 60

**USING THE REMOTE
CONTROL UNIT** 61 – 72

Slow-Motion Playback, Frame-By-Frame
Playback and Playback Zoom 63

Playback Special Effects 64

Random Assemble Editing 65

For More Accurate Editing 69

Audio Dubbing 71

Insert Editing 72

TROUBLESHOOTING 73 – 79

USER MAINTENANCE 80

INDEX 81 – 88

Jack Box 81

Controls, Connectors And Indicators 82

Indications 84

CAUTIONS 89 – 91

TERMS 92 – 93

SPECIFICATIONS 94 – 95

LYT0755-001A

EN

Dear Customer,

Thank you for purchasing this digital video camera. Before use, please read the safety information and precautions contained in the following pages to ensure safe use of this product.

Using This Instruction Manual

- All major sections and subsections are listed in the Table Of Contents on the cover page.
- Notes appear after most subsections. Be sure to read these as well.
- Basic and advanced features/operation are separated for easier reference.

It is recommended that you . . .

- refer to the Index (☞ pgs. 81 – 88) and familiarize yourself with button locations, etc. before use.
- read thoroughly the Safety Precautions. They contain extremely important information regarding the safe use of this product.

You are recommended to carefully read the cautions on pages 89 through 91 before use.

SAFETY PRECAUTIONS

WARNING:

TO PREVENT FIRE OR SHOCK HAZARD, DO NOT EXPOSE THIS UNIT TO RAIN OR MOISTURE.

**Caution: (applies to Jack Box)**

To reduce the risk of fire, do not remove cover. No user-serviceable parts inside. Refer servicing to qualified service person.

CAUTIONS:

- If you notice smoke or a peculiar smell coming from the camcorder or AC adapter/charger, shut it down and unplug it immediately. Continue using the camcorder or AC adapter/charger under these conditions could lead to fire or electric shock. Contact your JVC dealer. Do not attempt to repair the malfunction yourself.
- To prevent shock, do not open the cabinet. No user serviceable parts inside. Refer servicing to qualified personnel.
- When you are not using the AC Power Adapter/Charger for a long period of time, it is recommended that you disconnect the power cord from AC outlet.

NOTES:

- The rating plate (serial number plate) and safety caution are on the bottom and/or the back of the main unit.
- The rating plate (serial number plate) of the AC Power Adapter/Charger is on its bottom.

This camcorder is designed to be used with PAL-type colour television signals. It cannot be used for playback with a television of a different standard. However, live recording and LCD monitor/ viewfinder playback are possible anywhere. Use the JVC BN-V408U/V416U/V428U battery packs and, to recharge them, the provided multi-voltage AC Power Adapter/Charger. (An appropriate conversion adapter may be necessary to accommodate different designs of AC outlets in different countries.)

When the equipment is installed in a cabinet or on a shelf, make sure that it has sufficient space on all sides to allow for ventilation (10 cm or more on both sides, on top and at the rear).

Do not block the ventilation holes.

(If the ventilation holes are blocked by a newspaper, or cloth etc. the heat may not be able to get out.)

No naked flame sources, such as lighted candles, should be placed on the apparatus.

When discarding batteries, environmental problems must be considered and the local rules or laws governing the disposal of these batteries must be followed strictly.

The apparatus shall not be exposed to dripping or splashing.

Do not use this equipment in a bathroom or places with water.

Also do not place any containers filled with water or liquids (such as cosmetics or medicines, flower vases, potted plants, cups etc.) on top of this unit.

(If water or liquid is allowed to enter this equipment, fire or electric shock may be caused.)

Do not point the lens or the viewfinder directly into the sun. This can cause eye injuries, as well as lead to the malfunctioning of internal circuitry. There is also a risk of fire or electric shock.

CAUTION!

The following notes concern possible physical damage to the camcorder and to the user.

When carrying, be sure to always securely attach and use the provided shoulder strap. Carrying or holding the camcorder by the viewfinder and/or the LCD monitor can result in dropping the unit, or in a malfunction.

Take care not to get your finger caught in the cassette holder cover. Do not let children operate the camcorder, as they are particularly susceptible to this type of injury.

Do not use a tripod on unsteady or unlevel surfaces. It could tip over, causing serious damage to the camcorder.

CAUTION!

Attaching the Jack Box to the camcorder with cables (S-Video, Editing, DC, etc.) connected, then leaving it on top of the TV is not recommended, as tripping on the cables will cause the camcorder to fall, resulting in damage.

Attach only the optional JVC VL-V3U Video Light, VL-F3U Video Flash or MZ-V3U Stereo Zoom Microphone to the camcorder's Info-Shoe.

Mini **DV** PAL



MultiMediaCard

- This camcorder is designed exclusively for the digital video cassette, SD Memory Card and MultiMediaCard. Only cassettes marked "Mini DV" and memory cards marked "SD" or "MultiMediaCard" can be used with this unit.

Before recording an important scene . . .

.... make sure you only use cassettes with the Mini DV mark **Mini DV**.

.... make sure you only use memory cards with the mark **SD** or *MultiMediaCard*.

.... remember that this camcorder is not compatible with other digital video formats.

.... remember that this camcorder is intended for private consumer use only. Any commercial use without proper permission is prohibited. (Even if you record an event such as a show, performance or exhibition for personal enjoyment, it is strongly recommended that you obtain permission beforehand.)

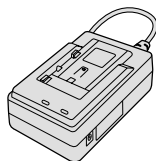

- AC Power Adapter/Charger
AA-V40EA, AA-V40A,
AA-V40A-S, AA-V40SH or
AA-V40ED

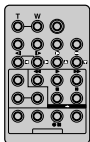

- Remote Control Unit
RM-V716U

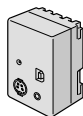

- Jack Box
CU-V504U

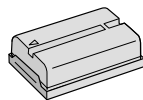

- Battery Pack
BN-V408U

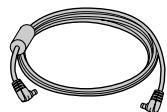

- DC Cord



- Core Filter
(for an optional
external microphone)



- Lens Hood
(See below for
attachment)



- AAA (R03) Battery x 2
(for remote control unit)



- S-Video Cable



- Editing Cable



- Audio/Video Cable
(ø3.5 mini-plug to
RCA plug)

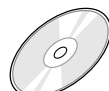

- CD-ROM
The CD ROM contains
the following 5 software
programmes:

- USB Driver Soft
(for Windows®)
- USB Driver Soft
(for Macintosh®)

Presto!

- Mr. Photo
- PhotoAlbum
- ImageFolio

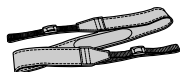

- Shoulder Strap

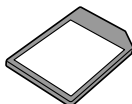

- MultiMediaCard
(GR-DV2000EA/A/A-S: 16 MB,
GR-DV2000SH/ED: 8 MB)
(Already inserted in the camcorder)

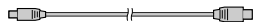

- USB Cable

How To Attach The Lens Hood

The provided lens hood helps block out glare when shooting under bright sunlight, the same way professional photographers do.

Align the lens hood with the camcorder's lens and screw it in clockwise.

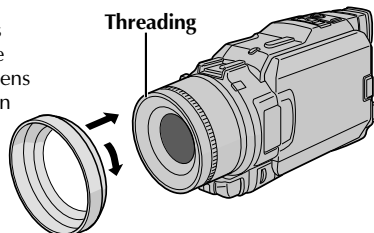

How To Attach Core Filter

Attach the provided Core Filter to an optional external microphone. Core Filter reduces interference.

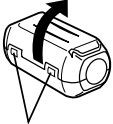
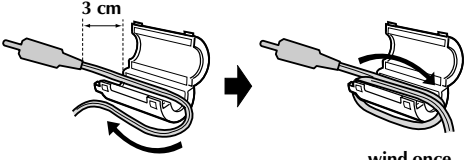
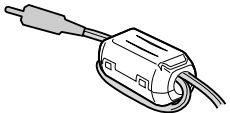
<p>1</p>  <p>Stopper</p> <p>Release the stoppers on both ends of the Core Filter.</p>	<p>2</p>  <p>3 cm</p> <p>wind once</p> <p>Run the cable through the Core Filter, leaving approx. 3 cm of cable between the cable plug and the Core Filter. Wind the cable around the outside of the Core Filter as shown in the illustration.</p> <ul style="list-style-type: none"> • Wind the cable so that it is not slack. <p>NOTE: Take care not to damage the cable.</p>	<p>3</p>  <p>Close the Core Filter until it clicks shut.</p>
--	---	---

- When connecting cables, attach the end with the Core Filter to the camcorder.

AUTOMATIC DEMONSTRATION

Automatic Demonstration takes place when “DEMO MODE” is set to “ON” (factory-preset).

- Available when the Power Switch is set to “A” or “M” and no cassette is in the camcorder.
- Performing any operation during the demonstration stops the demonstration temporarily. If no operation is performed for more than 1 minute after that, the demonstration will resume.
- “DEMO MODE” remains “ON” even if the camcorder power is turned off.
- To cancel Automatic Demonstration:
 1. Set the Power Switch to “M” while pressing down the Lock Button located on the switch and press the **MENU** wheel. The Menu Screen appears.
 2. Rotate the **MENU** wheel to select “SYSTEM” and press it. The SYSTEM Menu appears.
 3. Rotate the **MENU** wheel to select “DEMO MODE” and press it. The Sub Menu appears.
 4. Rotate the **MENU** wheel to select “OFF” and press it.
 5. Rotate the **MENU** wheel to select “◀RETURN”, and press it twice. The normal screen appears.

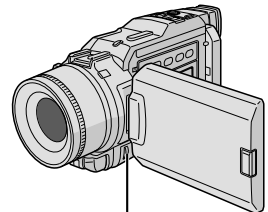

MENU Wheel

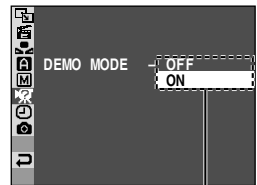

Sub Menu

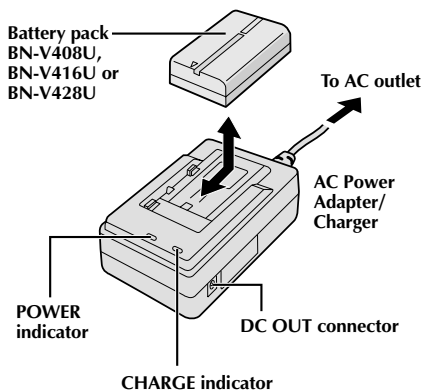

Battery pack	Fully charging time
BN-V408U	approx. 1 hr. 30 min.
BN-V416U (optional)	approx. 2 hrs.
BN-V428U (optional)	approx. 3 hrs. 20 min.

NOTES:

- If the protective cap is attached to the battery pack, remove it first.
- Perform charging where the temperature is between 10°C and 35°C. 20°C to 25°C is the ideal temperature range for charging. If the environment is too cold, charging may be incomplete.
- Charging times noted above are for a fully discharged battery pack.
- Charging time varies according to the ambient temperature and the status of the battery pack.
- To avoid interference with reception, do not use the AC Power Adapter/Charger near a radio.
- If you connect the camcorder's DC cord to the adapter during battery charging, power is supplied to the camcorder and charging stops.
- Since the AC Power Adapter/Charger processes electricity internally, it becomes warm during use. Be sure to use it only in well-ventilated areas.
- When charging the battery pack for the first time or after a long storage period, the CHARGE indicator may not light. In this case, remove the battery pack from the AC Power Adapter/Charger, then try charging again.
- If the battery operation time remains extremely short even after having been fully charged, the battery is worn out and needs to be replaced. Please purchase a new one.

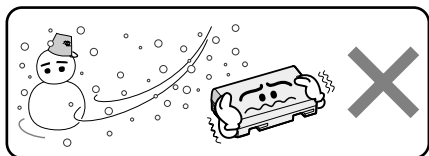

Lithium-ion is vulnerable in colder temperatures.



Power

This camcorder's 2-way power supply system lets you choose the most appropriate source of power. Do not use provided power supply units with other equipment.

CHARGING THE BATTERY PACK

- 1 Make sure you unplug the camcorder's DC cord from the AC Power Adapter/Charger. Plug the AC Adapter/Charger's power cord into an AC outlet. The POWER indicator lights.
- 2 Attach the battery pack with the ⊕ ⊖ mark aligned with the corresponding marks on the AC Power Adapter/Charger. The CHARGE indicator begins blinking to indicate charging has started.
- 3 When the CHARGE indicator stops blinking but stays lit, charging is finished. Slide the battery and lift off. Remember to unplug the AC Adapter/Charger's power cord from the AC outlet.

About Batteries

DANGER! Do not attempt to take the batteries apart, or expose them to flame or excessive heat, as it may cause a fire or explosion.

WARNING! Do not allow the battery or its terminals to come in contact with metals, as this can result in a short circuit and possibly start a fire.

The Benefits Of Lithium-Ion Batteries

Lithium-ion battery packs are small but have a large power capacity. However, when one is exposed to cold temperatures (below 10°C), its usage time becomes shorter and it may cease to function. If this happens, place the battery pack in your pocket or other warm, protected place for a short time, then re-attach it to the camcorder. As long as the battery pack itself is not cold, it should not affect performance.

(If you're using a heating pad, make sure the battery pack does not come in direct contact with it.)

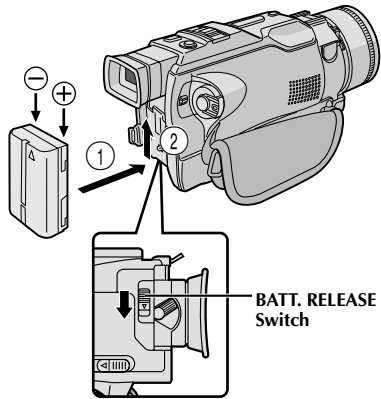
**ATTENTION:**

Before detaching the power source, make sure that the camcorder's power is turned off. Failure to do so can result in a camcorder malfunction.

INFORMATION:

The extended-use battery pack kit is a set composed of a battery pack and AC Power Adapter/Charger:
 VU-V840 KIT : BN-V840U battery pack & AA-V15 AC Power Adapter/Charger
 VU-V856 KIT : BN-V856U battery pack & AA-V80 AC Power Adapter/Charger
 Read the kit's instruction manual before using. Neither BN-V840U nor BN-V856U can be charged by using the AC Power Adapter/Charger provided with this camcorder. Use only the AA-V15 AC Power Adapter/Charger for BN-V840U battery pack and only AA-V80 AC Power Adapter/Charger for BN-V856U battery pack .

USING AC POWER

Use the AC Power Adapter/Charger (connect as shown in the illustration).

NOTES:

- The provided AC Power Adapter/Charger features automatic voltage selection in the AC range from 110 V to 240 V.
- For other notes, pg. 6.

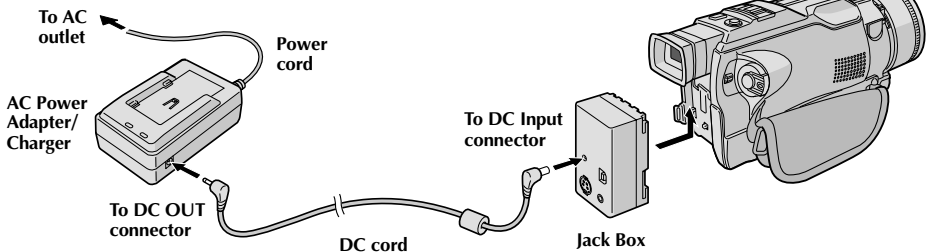
**USING THE BATTERY PACK**

- 1 With the arrow on the battery pack pointing upward, push the battery pack slightly against the battery pack mount ①.
- 2 Slide up the battery pack until it locks in place ②.
 - If the battery pack is attached with its ⊕ ⊖ mark set in the wrong direction, a malfunction may occur.

To Detach The Battery Pack . . .

.... slide the battery pack down slightly while sliding down **BATT. RELEASE** to detach it.

Approximate recording time

Battery pack	LCD monitor on/ Viewfinder off	LCD monitor off/ Viewfinder on
BN-V408U	1 hr. 5 min.	1 hr. 15 min.
BN-V416U (optional)	2 hrs. 10 min.	2 hrs. 30 min.
BN-V428U (optional)	3 hrs. 50 min.	4 hrs. 20 min.
BN-V840U (optional)	5 hrs. 20 min.	6 hrs. 10 min.
BN-V856U (optional)	7 hrs. 30 min.	8 hrs. 40 min.

NOTES:

- Recording time is reduced significantly under the following conditions:
 - Zoom or Record-Standby mode is engaged repeatedly.
 - The LCD monitor is used repeatedly.
 - The playback mode is engaged repeatedly.
- Before extended use, it is recommended that you prepare enough battery packs to cover 3 times the planned shooting time.

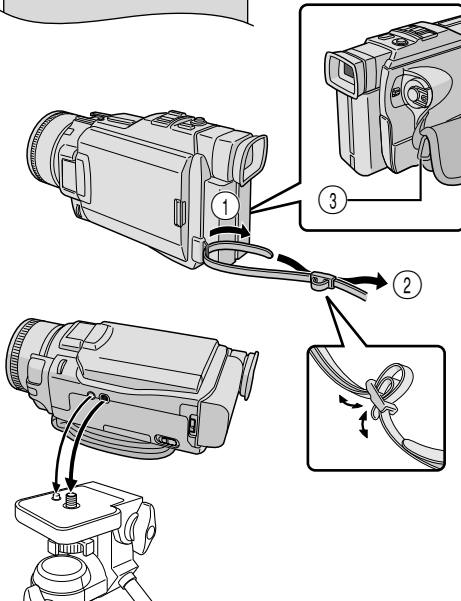
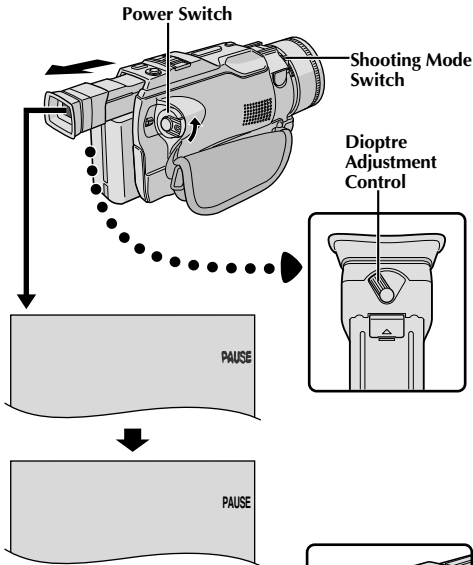
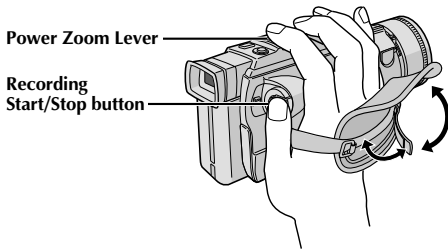

Grip Adjustment

- 1 Separate the Velcro strip.
- 2 Pass your right hand through the loop and grasp the grip.
- 3 Adjust so that your thumb and fingers can easily operate the Recording Start/Stop Button and Power Zoom Lever. Refasten the Velcro strip.

Viewfinder Adjustment

- 1 Set the Power Switch to "A" or "M" while pressing down the Lock Button located on the switch. Set the Shooting Mode Switch to any position.
- 2 Pull out the viewfinder fully and adjust it manually for best viewability.
- 3 Turn the Dioptre Adjustment Control until the indications in the viewfinder are clearly focused.

Shoulder Strap Attachment

- 1 Following the illustration, thread the strap through the eyelet ①, then fold it back and thread it through the buckle ②. Repeat the procedure to attach the other end of the strap to the other eyelet ③, making sure the strap is not twisted.

Tripod Mounting

- 1 Align the screw and camera direction stud on the tripod with the camera's mounting socket and stud hole. Then tighten the screw.
 - Some tripods are not equipped with studs.

CAUTION:

When using a tripod, be sure to open and extend its legs fully to stabilise the camcorder. To prevent damage to the unit caused by falling over, do not use a small-sized tripod.

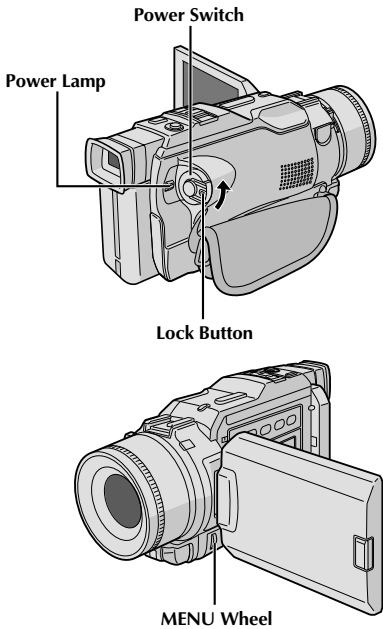

Date/Time Settings

The date/time is recorded onto the tape at all times, but its display can be turned on or off during playback (see pg. 39).

- 1** Set the Power Switch to “” while pressing down the Lock Button located on the switch, and open the LCD monitor fully or pull out the viewfinder fully. The power lamp lights and the camcorder is turned on.
- 2** Press the **MENU** wheel. The Menu Screen appears.
- 3** Rotate the **MENU** wheel to select “ DISPLAY”. Press it and the DISPLAY Menu appears.
- 4** Rotate the **MENU** wheel to select “CLOCK ADJ.”. Press it and “day” is highlighted. Rotate the **MENU** wheel to input the day. Press it. Repeat to input the month, year, hour and minute. Rotate the **MENU** wheel to select “RETURN”, and press it twice. The Menu Screen closes.

Built-in Clock's Rechargeable Lithium Battery

To store the date/time in memory, the clock's rechargeable lithium battery is integrated in the camcorder. While the camcorder is connected to an AC outlet using the AC Power Adapter/Charger, or while the battery pack attached to the camcorder continues to supply power, the clock's rechargeable lithium battery is always charged. However, if the camcorder is not used for approx. 3 months, the clock's lithium battery will become discharged and the date/time stored in memory will be lost. When this occurs, first connect the camcorder to an AC outlet using the AC Power Adapter/Charger for over 24 hours to charge the clock's rechargeable lithium battery. Then perform the date/time setting before using the camcorder. Note that the camcorder can be used without setting the date/time.

NOTE:

Even if you select “CLOCK ADJ.”, if the parameter is not highlighted the camcorder's internal clock continues to operate. Once you move the highlight bar to the first date/time parameter (day), the clock stops. When you finish setting the minute and press the **MENU** wheel, the date and time begin operation from the date and time you just set.

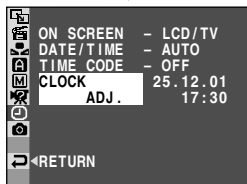
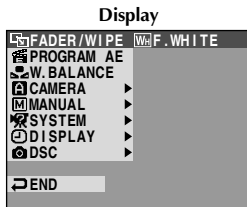

DISPLAY Menu

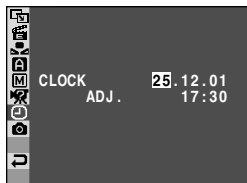

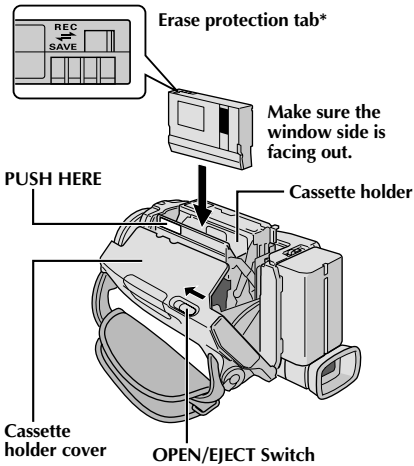

* To Protect Valuable Recordings . . .

.... slide the erase protection tab on the back of the tape in the direction of "SAVE". This prevents the tape from being recorded over. To record on this tape, slide the tab back to "REC" before loading it.

Be sure to press only the section labeled "PUSH HERE" to close the cassette holder; touching other parts may cause your finger to get caught in the cassette holder, resulting in injury or product damage.

NOTES:

- It takes a few seconds for the cassette holder to open. Do not apply force.
- If you wait a few seconds and the cassette holder does not open, close the cassette holder cover and try again. If the cassette holder still does not open, turn the camcorder off then on again.
- If the tape does not load properly, open the cassette holder cover fully and remove the cassette. A few minutes later, insert it again.
- When the camcorder is suddenly moved from a cold place to a warm environment, wait a short time before opening the cassette holder cover.
- Closing the cassette holder cover before the cassette holder comes out may cause damage to the camcorder.
- Even when the camcorder is switched off, a cassette can be loaded or unloaded. After the cassette holder is closed with the camcorder switched off, however, it may not recede. It is recommended to turn the power on before loading or unloading.
- When resuming recording, once you open the cassette holder cover a blank portion will be recorded on the tape or a previously recorded scene will be erased (recorded over) regardless of whether the cassette holder came out or not. See page 21 for information about recording from the middle of a tape.

Loading/Unloading A Cassette

The camcorder needs to be powered up to load or eject a cassette.

- 1 Slide and hold **OPEN/EJECT** in the direction of the arrow then pull the cassette holder cover open until it locks. The cassette holder opens automatically.
 - Do not touch internal components.
- 2 Insert or remove a tape and press "PUSH HERE" to close the cassette holder.
 - Once the cassette holder is closed, it recedes automatically. Wait until it recedes completely before closing the cassette holder cover.
 - When the battery's charge is low, you may not be able to close the cassette holder cover. Do not apply force. Replace the battery with a fully charged one before continuing.
- 3 Close the cassette holder cover firmly until it locks into place.

Approximate recording time

Tape	Recording mode	
	SP	LP
30 min.	30 min.	45 min.
60 min.	60 min.	90 min.
80 min.	80 min.	120 min.

Card Cover

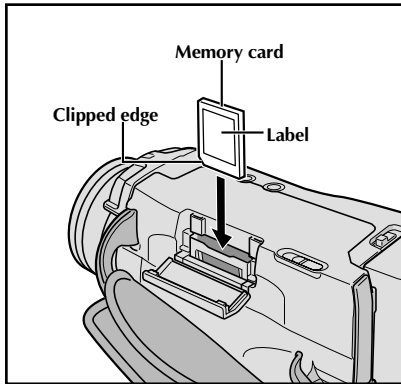
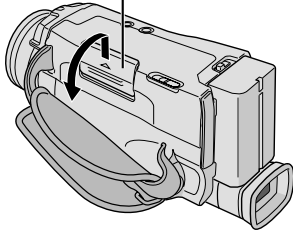

Loading A Memory Card

The provided MultiMediaCard is already inserted in the camcorder when you receive the camcorder.

- 1** Make sure the camcorder's power is off.
- 2** Open the card cover (**MEMORY CARD**).
- 3** Insert the memory card clipped edge first.
 - Do not touch the terminal on the reverse side of the label.
- 4** To close the card cover, push it until you hear a click.

To Unload A Memory Card . . .

.... in step 3 push the memory card, which then comes out of the camcorder automatically. Pull it out and close the card cover.

NOTES:

- Be sure to use only SD Memory Cards marked "SD" or MultiMediaCards marked "MultiMediaCard".
- Some brands of memory cards are not compatible with this camcorder. Before purchasing a memory card, consult its manufacturer or dealer.
- Before using a new memory card, it is necessary to **FORMAT** the card.  pg. 47.
- Even if a memory card is inserted in the camcorder, the camcorder may not recognize it. In this case, remove the memory card once and insert it again.

ATTENTION:

Do not insert/remove the memory card while the camcorder is turned on, as this may cause the memory card to be corrupted or cause the camcorder to become unable to recognize whether or not the card is installed.

To turn on the camcorder, first set the Power Switch to any operation mode except "OFF" while pressing down the Lock Button located on the switch, then pull out the viewfinder fully or open the LCD monitor fully.

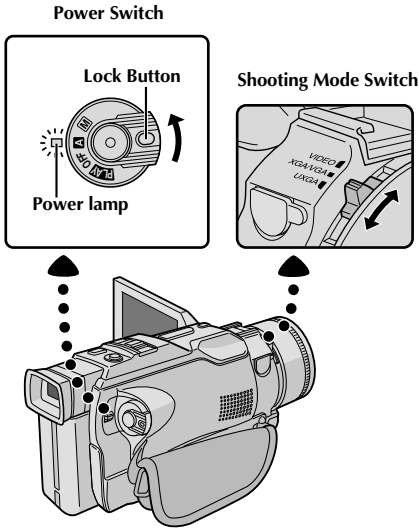

When the Power Switch is set to "A", "A" appears. When set to "M" or "PLAY", there is no indication.



The following indications appear in the upper left corner, depending on the Shooting Mode Switch position.

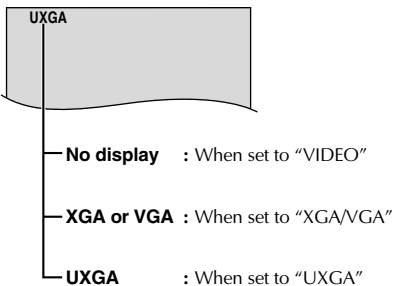

Operation Mode

Choose the appropriate operation mode according to your preference using the Power Switch and Shooting Mode Switch.

Power Switch Position	
M (Manual):	Allows you to set various recording functions using the Menu. If you want more creative capabilities than Full Auto recording, try this mode.
A (Full Auto):	Allows you to record using NO special effects or manual adjustments. Suitable for standard recording.
OFF:	Allows you to switch off the camcorder.
PLAY :	Allows you to play back a recording on the tape, to display an image stored in the memory card or to transfer a still image recorded on the tape or in the memory card to a computer.

Shooting Mode Switch Position	
VIDEO:	<ul style="list-style-type: none"> Allows you to record on a tape. Approx. 6 seconds of a still image can be inserted between video recordings (☞ pg. 18). Zoom magnification over 10X is available (☞ pg. 20, 27). Allows you to record video on a tape and store still images in a memory card simultaneously (☞ pg. 24). Allows you to record moving images (successive jitter-free still images) with superior quality on a tape (☞ pg. 22). The still images can also be processed on a PC or printed out.
XGA/VGA:	<ul style="list-style-type: none"> Allows you to record still images in a memory card (☞ pg. 14, 19). File size: 1024 x 768 pixels (XGA) or 640 x 480 pixels (VGA)
UXGA:	<ul style="list-style-type: none"> Allows you to record still images in a memory card at high resolution (☞ pg. 14, 19). Suitable for recording still images with superior quality. File size: 1600 x 1200 pixels

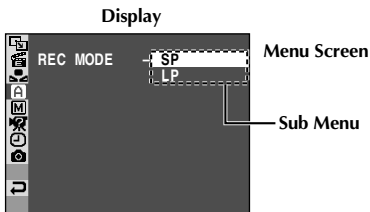
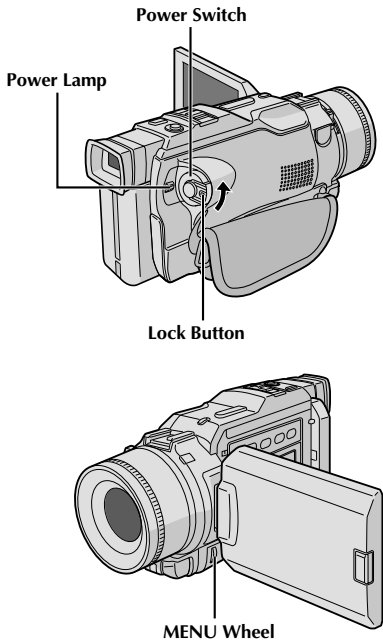

Recording Mode Setting

Set the tape recording mode depending on your preference.

- 1 Set the Power Switch to "M" while pressing down the Lock Button located on the switch, and open the LCD monitor fully or pull out the viewfinder fully. The power lamp lights and the camcorder is turned on.
- 2 Press the **MENU** wheel. The Menu Screen appears.
- 3 Rotate the **MENU** wheel to select "A CAMERA" and press it. The CAMERA Menu appears.
- 4 Rotate the **MENU** wheel to select "REC MODE" and press it. The Sub Menu appears. Select "SP" or "LP" by rotating the **MENU** wheel and press it. Rotate the **MENU** wheel to select "RETURN", and press it twice. The Menu Screen closes.
 - Audio Dubbing (pg. 71) and Insert Editing (pg. 72) are impossible on a tape recorded in the LP mode.
 - "LP" (Long Play) is more economical, providing 1.5 times the recording time.

NOTES:

- If the recording mode is switched during recording, the playback picture will be blurred at the switching point.
- It is recommended that tapes recorded in the LP mode on this camcorder be played back on this camcorder.
- During playback of a tape recorded on another camcorder, blocks of noise may appear or there may be momentary pauses in the sound.

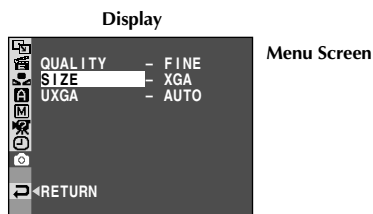
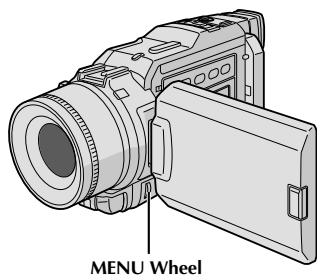
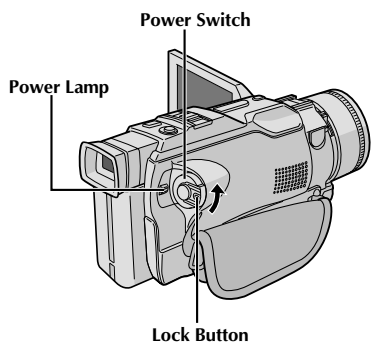

Picture Mode Setting

The Picture mode can be selected to best match your needs.

- 1 Set the Power Switch to “” while pressing down the Lock Button located on the switch, and open the LCD monitor fully or pull out the viewfinder fully. The power lamp lights and the camcorder turns on.
- 2 Press the **MENU** wheel. The Menu Screen appears.
- 3 Rotate the **MENU** wheel to select “ DSC” and press it. The DSC Menu appears.
- 4 Rotate the **MENU** wheel to select “QUALITY” and press it. The Sub Menu appears. Rotate the **MENU** wheel to select the desired mode and press it.
If you are recording with the Shooting Mode Switch (pg. 12) set to “XGA/VGA” . . . go to step 5.
If you are recording with the Shooting Mode Switch set to “UXGA” . . . go to step 6.
- 5 Rotate the **MENU** wheel to select “SIZE” and press it. The Sub Menu appears. Rotate the **MENU** wheel to select “XGA” or “VGA”.
Go to step 7.
- 6 Rotate the **MENU** wheel to select “UXGA” and press it. The Sub Menu appears. Rotate the **MENU** wheel to select the desired mode.
 AUTO : or appears when the **SNAPSHOT** button is pressed (pg. 19). Automatically processes the image according to the **DOUBLE** or **ENLARGE** methods described below, depending on the shooting situation or subject.
 DOUBLE : appears (pg. 19). Engages pixel-shift technology to double-expose the image and generate a UXGA-sized picture.
 ENLARGE : appears (pg. 19). Digitally enlarges the image to UXGA size.
- 7 Rotate the **MENU** wheel to select “◀RETURN”, and press it twice. The Menu Screen closes.

STORAGE CAPACITY

The number of storable images depends on the selected picture quality and size as well as the composition of the subjects in the images.

Approximate number of storable images

(with 16 MB MultiMediaCard)

SIZE	QUALITY	
	FINE	STANDARD
UXGA (1600 x 1200)	20	60
XGA (1024 x 768)	48	144
VGA (640 x 480)	100	300

Approximate number of storable images

(with 8 MB MultiMediaCard)

SIZE	QUALITY	
	FINE	STANDARD
UXGA (1600 x 1200)	10	30
XGA (1024 x 768)	24	72
VGA (640 x 480)	50	150

NOTES:

- If the Shooting Mode Switch is set to "XGA/VGA" or "UXGA" during video recording, the camcorder stops video recording.
- The camcorder automatically zooms out to less than 2X when the Shooting Mode Switch is set to "UXGA".
- With images shot in the UXGA mode . . .
 - the shutter speed is applicable only up to 1/500 in the "SPORTS" mode (☞ pg. 35).
 - Sepia and Monotone cannot be activated.
- If "DOUBLE" is selected in the UXGA mode, images may not be processed properly in the following situations:
 - when the subject has no contrast (difference in brightness and darkness).
 - when shooting in a dark place.
 - when the subject contains identical patterns that are regularly repeated.
 - when shooting under a flickering light such as a fluorescent light or candlelight.
 - when the subject is moving rapidly.
 - when there is excessive camera-shake.
- If "AUTO" is selected in the UXGA mode, and any of the shooting situations listed above are encountered, the camcorder will automatically process the image using the ENLARGE method.

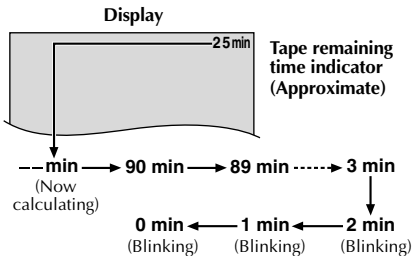
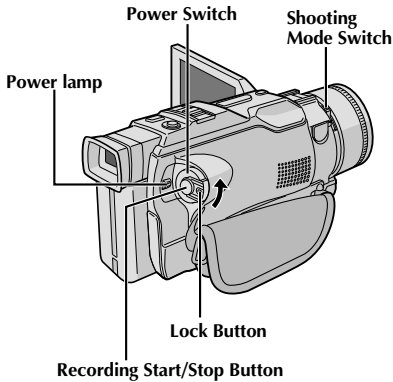

Tally lamp (lights while recording is in progress)

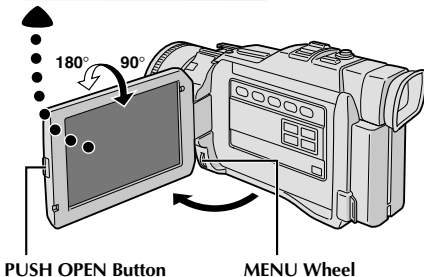
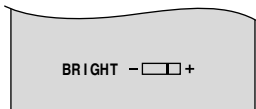
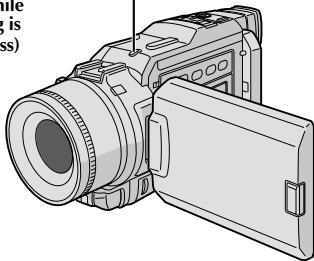

NOTE:

You should already have performed the procedures listed below. If not, do so before continuing.

- Power (☞ pg. 6)
- Grip Adjustment (☞ pg. 8)
- Viewfinder Adjustment (☞ pg. 8)
- Load A Cassette (☞ pg. 10)
- Recording Mode Setting (☞ pg. 13)

- 1 Set the Shooting Mode Switch to "VIDEO", then set the Power Switch to "A" or "M" while pressing down the Lock Button located on the switch. Make sure "CAMERA MODE" is set to "VIDEO" in the Menu Screen (☞ pg. 26, 27).

Shooting while using the viewfinder: Make sure the LCD monitor is closed and locked. Pull out the viewfinder fully.

- Be sure to pull out the viewfinder until you hear a click, otherwise it may be pushed back in during use.

Shooting while using the LCD monitor: Make sure the viewfinder is pushed back in. Press **PUSH OPEN** and open the LCD monitor fully. Tilt it upward/downward for best viewability.

- The power lamp lights and the camcorder enters the Record-Standby mode. "PAUSE" is displayed.

- 2 Press the Recording Start/Stop Button. "REC" appears while recording is in progress.

To Stop Recording . . .

.... press the Recording Start/Stop Button. The camcorder re-enters the Record-Standby mode.

To Adjust The Brightness Of The Display

.... rotate the **MENU** wheel until the bright level indicator on the display moves and the appropriate brightness is reached.

- It is also possible to adjust the brightness of the viewfinder.

NOTES:

- When you use the LCD monitor outdoors in direct sunlight, the LCD monitor may be difficult to see. If this happens, use the viewfinder instead.
- The image will not appear simultaneously in the LCD monitor and the viewfinder except during Interface Shooting.
- The cassette holder cannot be opened unless a power supply is attached.
- There may be a delay after you open the cassette holder cover until the cassette holder opens. Do not use force.
- Once the cassette holder is closed, it recedes automatically. Wait until it recedes completely before closing the cassette holder cover.
- The time required to calculate and display the remaining tape length, and the accuracy of the calculation, may vary according to the type of tape used.
- "TAPE END" appears when the tape reaches its end, and the power goes off automatically if left in this condition for 5 minutes. "TAPE END" also appears when a cassette at its end is loaded.
- If the Record-Standby mode continues for 5 minutes, the camcorder's power shuts off automatically. To turn the camcorder on again, push back and pull out the viewfinder again or close and re-open the LCD monitor.
- When a blank portion is left between recorded scenes on the tape, the time code is interrupted and errors may occur when editing the tape. To avoid this, refer to "Recording from the middle of a tape" (☞ pg. 21).
- During recording, sound is not heard from the speaker. To hear the sound, connect optional headphones to the PHONE connector. The sound volume is at the level it was adjusted to during playback (☞ pg. 38).
- To turn the tally lamp or beep sounds off, ☞ pg. 26, 29.

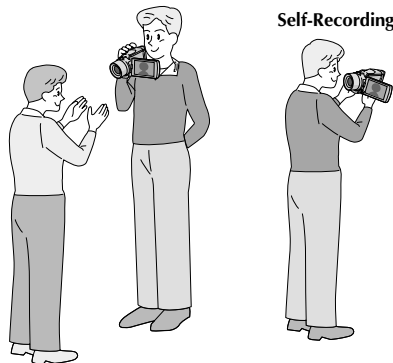

Self-Recording

JOURNALISTIC SHOOTING

In some situations, different shooting angles may provide more dramatic results. Hold the camcorder in the desired position and tilt the LCD monitor in the most convenient direction. It can rotate 270° (90° downward, 180° upward).

INTERFACE SHOOTING



The person you shoot can view himself/herself in the LCD monitor, and you can even shoot yourself while viewing your own image in the LCD monitor.

Open the LCD monitor and tilt it upward to 180° so that it faces forward. When the LCD monitor is tilted upward to an angle of over approx. 105°, the monitor image is inverted vertically. If the viewfinder is pulled out at that time, it also switches on.

Point the lens toward the subject (yourself when self-recording) and start recording.

During Interface Shooting, the monitor image and indications do not appear inverted as they would when viewing a mirror.

NOTES:

- During Interface Shooting, the "Tape Running" indicator and warning indications (☞ pg. 87, 88) are the only ones that are shown; they appear reversed in the display as they would when viewing a mirror, but are not reversed in the recording.
- The tape remaining indicator does not appear during interface shooting. However, when the remaining time reaches 2 minutes, the indicator appears showing the remaining time:  (blinking)  (blinking)  (blinking)

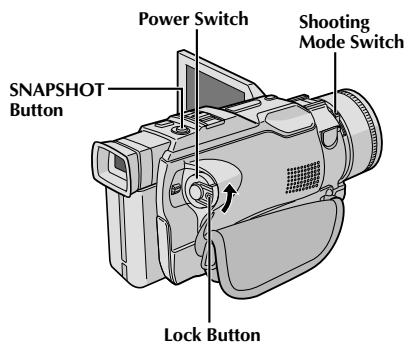

Display

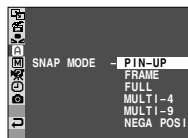

Menu Screen



FULL
Snapshot mode
with no frame* √

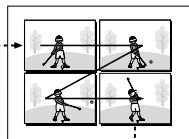

MULTI-4
Multi-Analyzer 4

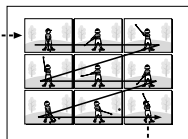

MULTI-9
Multi-Analyzer 9



NEGA POSI
Nega/Posi mode* √



PIN-UP
Pin-Up mode √



FRAME
Snapshot mode
with frame* √

Snapshot (For Video Recording)

This feature lets you record still images that look like photographs onto a tape.

SNAPSHOT MODE SELECTION

- 1** Set the Shooting Mode Switch to "VIDEO", then set the Power Switch to "M" while pressing down the Lock Button located on the switch. Pull out the viewfinder fully or open the LCD monitor fully.
- 2** Press the MENU wheel. The Menu Screen appears.
- 3** Rotate the MENU wheel to select "A CAMERA". Press it and the CAMERA Menu appears.
- 4** Rotate the MENU wheel to select "SNAP MODE", then press it.
- 5** Rotate the MENU wheel to select the desired Snapshot mode, then press it.
Rotate the MENU wheel to select "◀RETURN" and press it twice. The Menu Screen closes.

SNAPSHOT RECORDING

- 1** Set "CAMERA MODE" to "VIDEO" or "PS-VIDEO" in the Menu Screen (☞ pg. 26, 27).
- 2** Press **SNAPSHOT**.
If you press during Record-Standby . . .
..... "PHOTO" appears and a still image will be recorded for approx. 6 seconds, then the camcorder re-enters the Record-Standby mode.
If you press during Recording . . .
..... "PHOTO" appears and a still image will be recorded for approx. 6 seconds, then the normal recording resumes.

Motor Drive Mode

Keeping **SNAPSHOT** pressed provides an effect similar to serial photography. (Interval between still images: approx. 1 second)

NOTES:

- To remove the shutter sound, ☞ "BEEP" on pg. 29.
- If Digital Zoom is used while in the "MULTI-4" or "MULTI-9" mode, Snapshot recording will be performed with 10X magnification.
- If Snapshot recording is not possible, "PHOTO" blinks when **SNAPSHOT** is pressed.
- If Programme AE with special effects (☞ pg. 34) is engaged, certain modes of Programme AE with special effects are disabled during Snapshot recording. In such a case, the icon blinks.
- If **SNAPSHOT** is pressed when "DIS" is set to "ON" (☞ pg. 27), the Stabiliser will be disabled.
- To dub images recorded on a tape to a memory card, ☞ pg. 60.
- When shooting in the Multi-Analyzer 4 or Multi-Analyzer 9 modes, the optional flash (☞ pg. 83) will not light.
- During playback as well, all snapshot modes except Nega/Posi mode are available when "COPY" is set to "OFF" in the Menu Screen (☞ pg. 39).
- When a headphone set is connected to the PHONE connector, the shutter sound is not heard from the speaker, however it is recorded onto the tape.

* There is the sound effect of a shutter closing.

√ When "FULL", "FRAME", "PIN-UP" or "NEGA POSI" is selected, snapshot recording will always be performed with higher quality (☞ pg. 22) even if "CAMERA MODE" is set to "VIDEO".

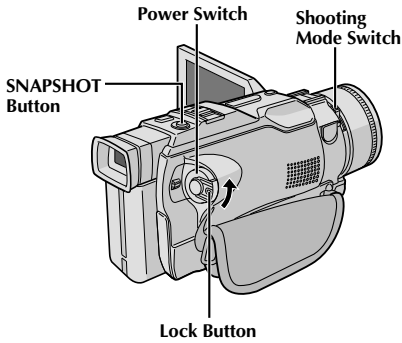

Picture Size

Displays the file size of the stored image: UXGA, XGA or VGA (☞ pg. 14).

Picture Quality

Displays the quality of the stored image: FINE or STD (standard) (in order of quality) (☞ pg. 14).

Number of shots taken

Displays the number of images that have already been shot.

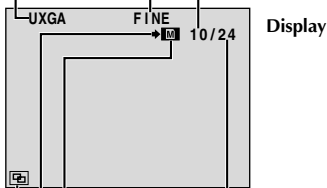

Total number of shots

Displays the approximate total number of shots that can be stored, including those already taken. The number increases or decreases depending on the shots stored, the Picture mode, Shooting mode, etc.

Card icon

Appears during shooting and blinks when a memory card is not loaded.

Shooting icon

Appears and blinks during shooting.

UXGA Mode icon

Displays the process utilized to create the UXGA size image: (DOUBLE) or (ENLARGE) (☞ pg. 14).



Snapshot mode with no frame

There is the sound of a shutter closing.

Basic Shooting (Snapshot)

You can use your camcorder as a Digital Still Camera for taking snapshots.

NOTE:

You should already have performed the procedures listed below. If not, do so before continuing.

- Power (☞ pg. 6)
- Grip Adjustment (☞ pg. 8)
- Viewfinder Adjustment (☞ pg. 8)
- Loading A Memory Card (☞ pg. 11)
- Picture Mode Setting (☞ pg. 14)

1 Set the Shooting Mode Switch to "XGA/VGA" or "UXGA", then set the Power Switch to "A" or "M" while pressing down the Lock Button located on the switch. Open the LCD monitor fully or pull out the viewfinder fully.

2 Press **SNAPSHOT** halfway. The screen becomes a still image, which is captured into the camcorder's memory. However, it is not recorded until **SNAPSHOT** is pressed fully.

- At this moment, if you release **SNAPSHOT**, snapshot recording will be cancelled.

3 Press **SNAPSHOT** fully. The image is recorded in the memory card .

- Still images are recorded in the snapshot mode with no frame.

To Delete Unwanted Still Images . . .

..... when unwanted still images are stored in the memory card or its memory is full, refer to "Deleting Images" (☞ pg. 45) and delete unwanted still images.

To Remove The Shutter Sound . . .

..... when you do not want to hear the shutter sound, set "BEEP" to "OFF" in the Menu Screen (☞ pg. 26, 29). The sound is no longer heard from the speaker.

NOTES:

- Even if "DIS" is set to "ON" (☞ pg. 27), the Stabiliser will be disabled.
- If Snapshot recording is not possible, "PHOTO" blinks when **SNAPSHOT** is pressed.
- If Programme AE with special effects (☞ pg. 34) is engaged, certain modes of Programme AE with special effects are disabled during Snapshot recording. In such a case, the icon blinks.
- If shooting is not performed for approx. 5 minutes when the Power Switch is set to "A" or "M" and power is supplied from the battery pack, the camcorder shuts off automatically to save power. To perform shooting again, close the LCD monitor and re-open it. When using the viewfinder, push back it in and pull it out again.
- The Motor Drive mode (☞ pg. 18) is disabled when the Shooting Mode Switch is set to "XGA/VGA" or "UXGA".
- When a headphone set is connected to the PHONE connector, the shutter sound is not heard from the speaker.
- Still images taken are compliant to DCF (Design rules for Camera File systems). They do not have any compatibility with devices which are not compliant to DCF.
- In the XGA mode, images shot using a 680,000-pixel Progressive Scan CCD (effective area: 630,000 pixels, 962 x 654 pixels) are converted and stored in the XGA mode file size (1024 x 768 pixels).

Zoom in (T: Telephoto)

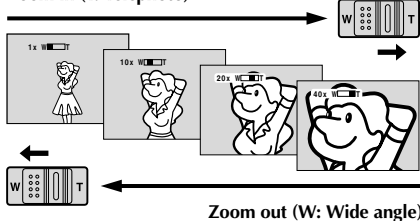

Zoom display

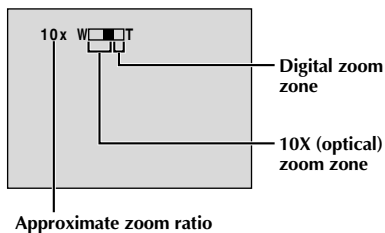

Power Zoom Lever

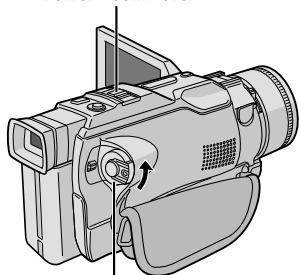

Power Switch

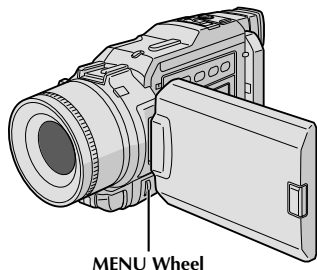
**FEATURE: Zooming****PURPOSE:**

To produce the zoom in/out effect, or an instantaneous change in image magnification.

OPERATION:**Zoom In**

Slide the Power Zoom Lever towards "T".

Zoom Out

Slide the Power Zoom Lever towards "W".

- The further you slide the Power Zoom Lever, the quicker the zoom action.

NOTES:

- Focusing may become unstable during Zooming. In this case, set the zoom while in Record-Standby, lock the focus by using the manual focus (☞ pg. 25), then zoom in or out in Record mode.
- Zooming is possible to a maximum of 300X, or it can be switched to 10X magnification using the optical zoom (☞ pg. 27).
- Zoom magnification of over 10X is done through Digital image processing, and is therefore called Digital Zoom.
- During Digital zoom, the quality of image may suffer.
- Digital zoom cannot be used in the following cases:
 - When digital image processing, such as Picture Wipe/Dissolve (☞ pg. 32, 33) or Video Echo (☞ pg. 34, 35), is activated.
 - When the Shooting Mode Switch is set to "UXGA" or "XGA/VGA" (☞ pg. 12).
 - When "CAMERA MODE" is set to "DUAL" in the Menu Screen (☞ pg. 26, 27).
 - When "CAMERA MODE" is set to "PS-VIDEO" and "WIDE MODE" is set to "PS-WIDE" in the Menu Screen (☞ pg. 26, 27).
- Macro shooting (as close as approx. 5 cm to the subject) is possible when the Power Zoom Lever is set all the way to "W". Also see "TELE MACRO" in the Menu Screen on page 28.

NOTE: Recording From The Middle Of A Tape

Time Code

During recording, a time code is recorded on the tape. This code is to confirm the location of the recorded scene on the tape during playback.

If recording starts from a blank portion, the time code begins counting from "00:00:00" (minute:second:frame). If recording starts from the end of a previously recorded scene, the time code continues from the last time code number.

To perform Random Assemble Editing (☞ pg. 65 – 70), time code is necessary. If during recording a blank portion is left partway through the tape, the time code is interrupted. When recording is resumed, the time code starts counting up again from "00:00:00". This means the camcorder may record the same time codes as those existing in a previously recorded scene. To prevent this, perform "Recording From The Middle of A Tape" below in the following cases;

- When shooting again after playing back a recorded tape.
- When power shuts off during shooting.
- When a tape is removed and re-inserted during shooting.
- When shooting using a partially recorded tape.
- When shooting on a blank portion located partway through the tape.
- When shooting again after shooting a scene then opening/closing the cassette holder cover.

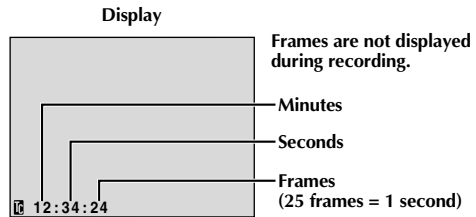

Recording From The Middle Of A Tape

1. Play back a tape or use Blank Search (☞ pg. 41) to find the spot at which you want to start recording, then engage the Still Playback mode (☞ pg. 38).
2. Set the Power Switch to "A" or "M" while pressing down the Lock Button located on the switch, then start recording.

NOTES:

- The time code cannot be reset.
- During fast-forwarding and rewinding, the time code indication does not move smoothly.
- The time code is displayed only when "TIME CODE" is set to "ON" (☞ pg. 29, 39).

When a blank portion is recorded on a tape

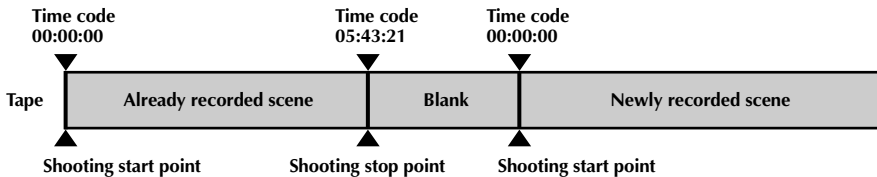

Proper recording

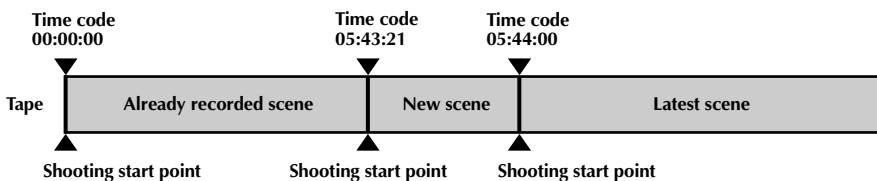

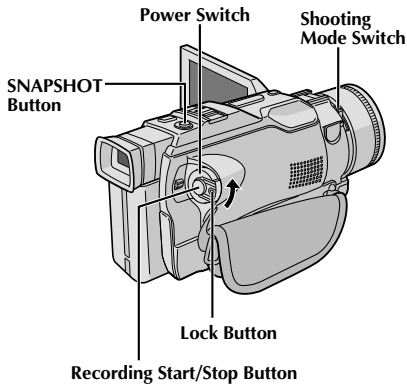

Progressive Mode Recording

This mode lets you record moving images (successive jitter-free still images) onto a tape. Images can then be played back jitter-free, with superior quality. High-resolution still images can also be processed on a personal computer or can be printed out (☞ pg. 55).

- 1** Set the Shooting Mode Switch to "VIDEO", then set the Power Switch to "☐" while pressing down the Lock Button located on the switch. Pull out the viewfinder fully or open the LCD monitor fully.
- 2** Set "CAMERA MODE" to "PS-VIDEO" in the Menu Screen (☞ pg. 26, 27).
- 3** To start Progressive Mode Recording, press the Recording Start/Stop Button.

To End Progressive Mode Recording . . .

.... press the Recording Start/Stop Button. The camcorder enters the Record-Standby mode.

NOTES:

- When an image recorded using the Progressive Mode is played back, the image may not look natural.
- When "CAMERA MODE" is set to "PS-VIDEO", Picture Wipe/Dissolve (☞ pg. 32) and some Programme AE with special effects (☞ pg. 34) cannot be used.
- If **SNAPSHOT** is pressed in the PS-VIDEO mode, a snapshot will be recorded with higher quality than in VIDEO mode. However, "MULTI-4" and "MULTI-9" cannot be used (☞ pg. 18).

Description of Progressive Scan CCD

Progressive Scan is a special image sensing method which, unlike conventional interlace scanning, is able to pick up all the lines of picture information in one Scan. Since the Progressive Scan CCD is capable of outputting 50 full Frames* per second — twice the amount of conventional systems — it is able to deliver a high quality picture even when its output signal is converted to a format that can be viewed on a TV screen.

*A PAL TV screen image is composed of 25 Frames per second. 1 Frame is made up of 2 Fields.

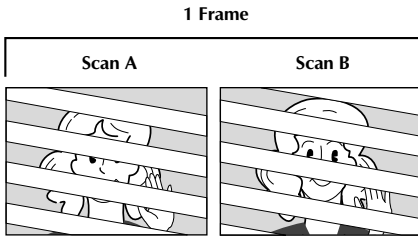

1. Regular shooting of moving images

Records 25 odd and 25 even image Fields, for a total of 50 per second. Since there is a time lag between an odd and even Field, when they are combined to make 1 Frame the part of the image that is moving appears as image jitter. **However, during normal playback, the moving picture looks smooth and natural.**

2. Progressive mode shooting of moving images (Progressive Mode Recording pg. 22)

Scan A is recorded, divided into an odd- and even-number Field, and then Scan B is skipped. Scans C and D are handled in the same way as Scans A and B, as illustrated below, thereby recording 25 Frames per second.

Since each recorded odd- and even-number Field originates from the same Scan there is no time lag between them, and so when they are combined into a Frame and a **still image is displayed on a TV or PC monitor the picture does not look jittery. However, when moving images are played back, the picture can look unnatural.**

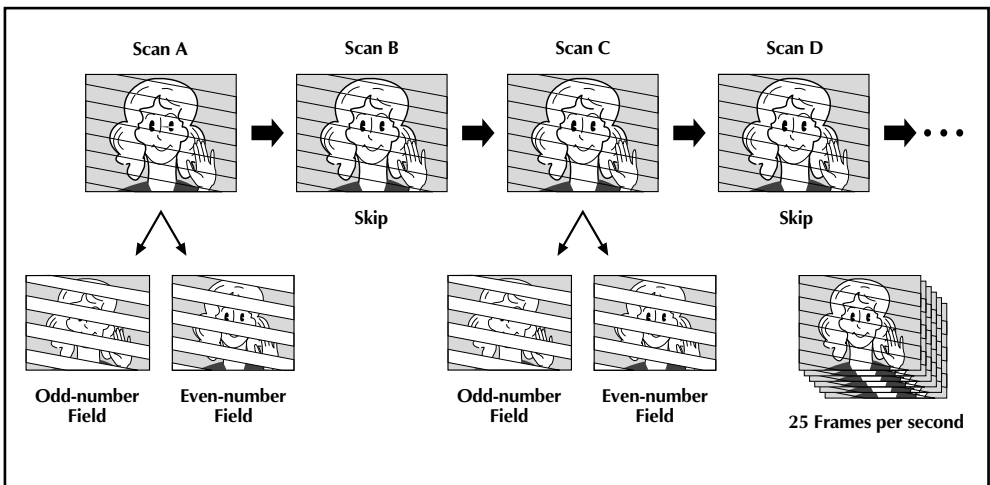

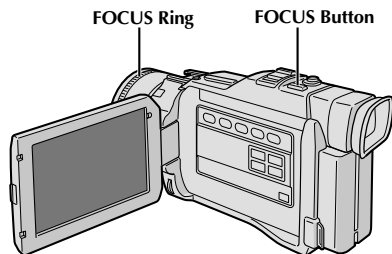
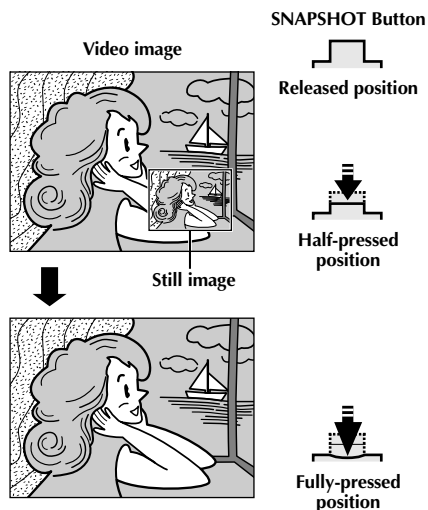
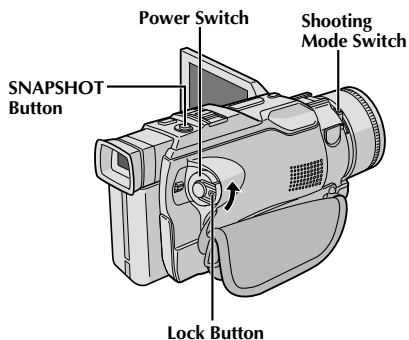

Dual Shooting

Lets you record images on a tape and store still images in a memory card simultaneously. In other words, it is possible to store still images in the memory card without interrupting image recording on the tape.

- 1** Set the Shooting Mode Switch to "VIDEO", then set the Power Switch to "M" while pressing down the Lock Button located on the switch. Pull out the viewfinder fully or open the LCD monitor fully.
- 2** Set "CAMERA MODE" to "DUAL" in the Menu Screen (☞ pg. 26, 27).
- 3** While recording to a tape, press **SNAPSHOT** halfway. A still image is displayed in the lower right corner of the screen where the video image being recorded is displayed.
 - At this moment, if you release **SNAPSHOT**, snapshot recording will be cancelled.
- 4** Press **SNAPSHOT** fully. The displayed still image is stored in the memory card.

NOTES:

- If **SNAPSHOT** is pressed in the Record-Standby mode, only a still image is stored in the memory card. Video recording does not take place.
- If **SNAPSHOT** is pressed when "DIS" is set to "ON" (☞ pg. 27), the Stabiliser will be disabled.
- The Stabiliser is less effective in the DUAL mode than in other modes.
- Still images are stored in the memory card in VGA mode file size (☞ pg. 12).
- When "CAMERA MODE" is set to "DUAL", all Fade/Wipe Effects and some Programme AE with special effects cannot be used (☞ pg. 32 – 35).
- The optional flash (☞ pg. 3, 83) will not light during video recording.

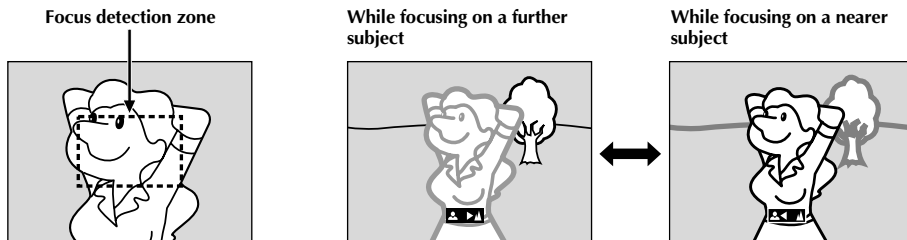

FEATURE: Auto Focus

PURPOSE:

The camcorder's Full Range AF system offers continuous shooting ability from close-up (as close as approx. 5 cm to the subject) to infinity.

However, correct focus may not be obtainable in the situations listed below (in these cases use manual focusing):

- When two subjects overlap in the same scene.
- When illumination is low.*
- When the subject has no contrast (difference in brightness and darkness), such as a flat, one-colour wall, or a clear, blue sky.*
- When a dark object is barely visible in the viewfinder.*
- When the scene contains minute patterns or identical patterns that are regularly repeated.
- When the scene is affected by sunbeams or light reflecting off the surface of a body of water.
- When shooting a scene with a high-contrast background.

* The following low-contrast warnings appear blinking: ▲, ◀, ▶ and 👤

NOTES:

- If the lens is smeared or blurred, accurate focusing is not possible. Keep the lens clean, wiping with a piece of soft cloth if it gets dirty. When condensation occurs, wipe with a soft cloth or wait for it to dry naturally.
- When shooting a subject close to the lens, zoom out first (☞ pg. 20). If zoomed-in in the auto focus mode, the camcorder may automatically zoom out depending on the distance between the camcorder and the subject. This will not occur when "TELE MACRO" (☞ pg. 28) is activated.

FEATURE: Manual Focus

PURPOSE:

To obtain correct focus.

OPERATION:

- 1) If you are using the viewfinder, you should already have made the necessary viewfinder adjustments (☞ pg. 8).
 - 2) Set the Power Switch to "M" while pressing down the Lock Button located on the switch and set the Shooting Mode Switch to "VIDEO", then press **FOCUS**. The manual focus indicator appears.
 - 3) To focus on a farther subject, rotate the Focus Ring clockwise. "▶" appears and blinks.
To focus on a nearer subject, rotate the Focus Ring counterclockwise. "◀" appears and blinks.
- To reset to Auto Focus, press **FOCUS** or set the Power Switch to "A".

NOTES:

- Be sure to focus the lens in the maximum telephoto position when you use the Manual Focus mode. If you focus in on a subject in the wide-angle position, sharply focused images cannot be obtained when zoomed up because the depth-of-field is reduced at longer focal lengths.
- When the focus level cannot be adjusted any further or closer, "▲" or "👤" will blink.

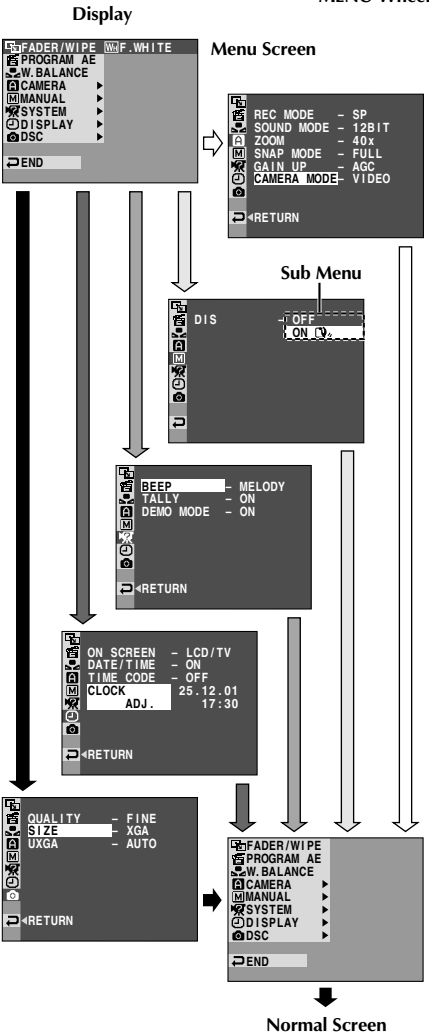
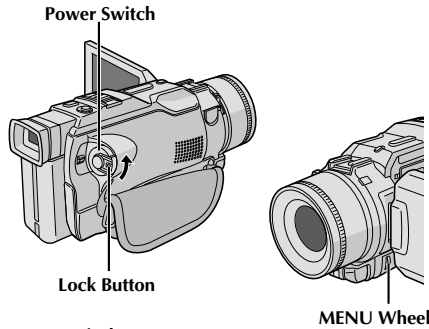







Using Menus For Detailed Adjustment

This camcorder is equipped with an easy-to-use, on-screen menu system that simplifies many of the more detailed camcorder settings (pg. 27 – 29).

- 1 Set the Power Switch to “” while pressing down the Lock Button located on the switch, then pull out the viewfinder fully or open the LCD monitor fully.
- 2 Press the MENU wheel. The Menu Screen appears.
- 3 Rotate the MENU wheel to select the desired function menu, and press it. The selected function menu appears.
- 4 Function menu setting depends on the function.
 - If you have selected “ FADER/WIPE”, “ PROGRAM AE” or “ W. BALANCE” ...* see pg. 27.
 - If you have selected “ CAMERA”, “ MANUAL”, “ SYSTEM”, “ DISPLAY” or “ DSC” ...* see pg. 28.
- 5 Rotate the MENU wheel to select the desired function and press it. The Sub Menu appears. Then, rotate the MENU wheel to select the parameter, and press it. Selection is complete.
- 6 Rotate the MENU wheel to select “ RETURN” and press it twice. The Menu Screen closes.





- The icon represents “END”.

Menu Screen Explanations

 FADER/WIPE		Refer to “Fade/Wipe Effects” (☞ pg. 32, 33).	
 PROGRAM AE		Refer to “Programme AE With Special Effects” (☞ pg. 34, 35).	
 W.BALANCE		Refer to “White Balance Adjustment” and “Manual White Balance Operation” (☞ pg. 37).	
 CAMERA	REC MODE	Allows you to set the video recording mode (SP or LP) depending on your preference (☞ pg. 13).	
	SOUND MODE	12 BIT	Enables video recording of stereo sound on four separate channels, and is recommended for use when performing audio dubbing. (Equivalent to the 32 kHz mode of previous models)
		16 BIT	Enables video recording of stereo sound on two separate channels. (Equivalent to the 48 kHz mode of previous models)
	ZOOM	10X	When set to “10X” while using digital zoom, the zoom magnification will reset to 10X since digital zoom will be disengaged.
		40X	Allows you to use the Digital Zoom. By digitally processing and magnifying images, zooming is possible from 10X (the optical zoom limit), to a maximum of 40X digital magnification.
		300X	Allows you to use the Digital Zoom. By digitally processing and magnifying images, zooming is possible from 10X (the optical zoom limit), to a maximum of 300X digital magnification.
	SNAP MODE		Refer to “Snapshot (For Video Recording)” (☞ pg. 18).
	GAIN UP	OFF	Allows you to shoot dark scenes with no picture brightness adjustment.
		AGC	The overall appearance may be grainy, but the image is bright.
		AUTO 	The shutter speed is automatically adjusted (1/25 — 1/200 sec.). Shooting a subject in low or poor lighting at 1/25 sec. shutter speed provides a brighter image than in the AGC mode, but the subject’s movements are not smooth or natural. The overall appearance may be grainy. While the shutter speed is being automatically adjusted, “  A” is displayed.
	CAMERA MODE	VIDEO	Enables regular video shooting.
		DUAL	Enables “Dual Shooting” (☞ pg. 24).
PS-VIDEO		Enables “Progressive Mode Recording” (☞ pg. 22).	
 MANUAL	DIS	<p>To compensate for unstable images caused by camera-shake, particularly at high magnification.</p> <p>NOTES:</p> <ul style="list-style-type: none"> • Accurate stabilisation may not be possible if hand shake is excessive, or under the following conditions: <ul style="list-style-type: none"> • When shooting subjects with vertical or horizontal stripes. • When shooting dark or dim subjects. • When shooting subjects with excessive backlighting. • When shooting scenes with movement in various directions. • When shooting scenes with low-contrast backgrounds. • Switch off this mode when recording with the camcorder on a tripod. • The “,” indicator blinks or goes out if the Stabiliser cannot be used. 	
	ON 		



 : Factory-preset

NOTES:

- The “ CAMERA” settings are effective when the Power Switch is set to both “A” and “M”.
- The “ MANUAL” settings are effective only when the Power Switch is set to “M”.

CONTINUED ON NEXT PAGE

Menu Screen Explanations (cont.)

MANUAL	SELF-TIMER		Refer to "Self-Timer" (☞ pg. 30).
	5S	OFF	Refer to "5-Second Recording" (☞ pg. 31).
		5S	
		ANIM.	Allows you to record a few frames only. By using an inanimate object and changing its position between shots, you can record the subject as though it is moving (☞ pg. 31).
	TELE MACRO	OFF	Usually the distance to a subject where the lens is in focus depends on the zoom magnification. Unless there is a distance more than 1m to the subject, the lens is out of focus at the maximum telephoto setting. When set to "ON", you can shoot a subject as large as possible at a distance of approx. 60 cm. • Depending on the zoom position, the lens may go out of focus.
		ON	
	WIDE MODE	OFF	Records with no change in the screen ratio. For playback on a TV with a normal screen ratio.
		CINEMA <input type="checkbox"/>	Inserts black bands at the top and bottom of the screen. During playback on wide-screen TVs, the black bands at the top and bottom of the screen are cut and the screen ratio becomes 16:9. <input type="checkbox"/> appears. When using this mode, refer to your wide-screen TV's instruction manual. During playback/recording on 4:3 TVs/LCD monitor/viewfinder, black bands are inserted at the top and bottom of the screen and the image appears like a letterboxed 16:9 movie. • "CINEMA" mode is effective only when the Shooting Mode Switch is set to "VIDEO" (☞ pg. 12) and "CAMERA MODE" is set to "VIDEO" or "PS-VIDEO" in the Menu Screen (☞ pg. 27).
		SQUEEZE <input checked="" type="checkbox"/>	For playback on TVs with an aspect ratio of 16:9. Naturally expands the image to fit the screen without distortion. <input checked="" type="checkbox"/> appears. When using this mode, refer to your wide-screen TV's instruction manual. During playback/recording on 4:3 TVs/LCD monitor/viewfinder, the image is elongated vertically. • "SQUEEZE" mode is effective only when the Shooting Mode Switch is set to "VIDEO" (☞ pg. 12) and "CAMERA MODE" is set to "VIDEO" or "PS-VIDEO" in the Menu Screen (☞ pg. 27).
		PS-WIDE <input checked="" type="checkbox"/>	" SW " appears. The zoom range is extended beyond the maximum optical zoom wide angle range. This mode's wide angle setting is equivalent to using a 0.7X wide conversion lens. Zooming is possible from 0.7X to 10X. This mode is suitable for shooting in a small room. • "PS-WIDE" mode is effective only when the Shooting Mode Switch is set to "VIDEO" (☞ pg. 12) and "CAMERA MODE" is set to "PS-VIDEO" in the Menu Screen (☞ pg. 27).
	WIND CUT	OFF	Disengages the function which cuts down on noise created by wind.
		ON 	Helps cut down on noise created by wind. "  appears. The quality of the sound will change. This is normal.

: Factory-preset

NOTE:

The " MANUAL" settings are effective only when the Power Switch is set to "".

SYSTEM	BEEP	OFF	Even though not heard while shooting, shutter sound is recorded on the tape.
		BEEP	The beep sounds when the power is turned on or off, and at the beginning and end of recording. Also to activate the shutter sound effect (☞ pg. 18, 19).
		MELODY	Instead of a beep, a melody sounds when any operation is performed. It also activates the shutter sound effect (☞ pg. 18, 19).
	TALLY	OFF	The tally lamp remains off at all times.
		ON	The tally lamp comes on to signal the start of recording.
	DEMO MODE	OFF	Automatic demonstration will not take place.
ON		Demonstrates certain functions such as Programme AE with special effects, etc., and can be used to confirm how these functions operate. When “DEMO MODE” is set to “ON” and the Menu Screen is closed, demonstration starts. Performing any operation during the demonstration stops the demonstration temporarily. If no operation is performed for more than 1 minute after that, the demonstration will resume. NOTES: <ul style="list-style-type: none"> ● If a tape is in the camcorder, the demonstration cannot be turned on. ● “DEMO MODE” remains “ON” even if the camcorder power is turned off. ● If “DEMO MODE” remains “ON”, some functions will not be available. After viewing demo, set to “OFF”. 	
DISPLAY	ON SCREEN	LCD	Keeps the camcorder’s display (except the date, time and time code) from appearing on the connected TV screen.
		LCD/TV	Makes the camcorder’s display appear on screen when the camcorder is connected to a TV.
	DATE/TIME	OFF	The date/time does not appear.
		AUTO	Displays the date/time for approx. 5 seconds in the following cases: <ul style="list-style-type: none"> • When the Power Switch is set from “OFF” to “A” or “M”. • When video playback starts. The camcorder displays the date/time when scenes are recorded. • When the date is changed during video playback.
		ON	The date/time is always displayed.
	TIME CODE	OFF	Time code is not displayed.
		ON	Time code is displayed on the camcorder and on the connected TV. Frame numbers are not displayed during recording.
CLOCK ADJ.	Allows you to set the current date and time (☞ pg. 9).		
DSC	QUALITY	Refer to “Picture Mode Setting” (☞ pg. 14).	
	SIZE		
	UXGA		

☐ : Factory-preset

NOTES:

- “SYSTEM” and “DISPLAY” functions which are set when the Power Switch is set to “M” are also applied when the Power Switch is set to “PLAY” (☞ pg. 39). “CLOCK ADJ.” only appears when the Power Switch is set to “M”.
- The “DISPLAY” settings are effective even when the Power Switch is set to “A”.
- The “ON SCREEN” setting can also be changed by pressing the **DISPLAY** Button on the remote control (provided) (☞ pg. 53, 56, 66).

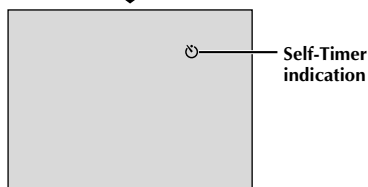
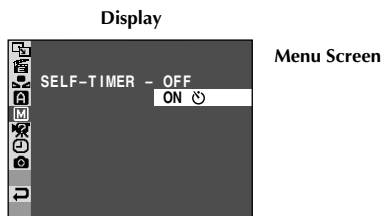
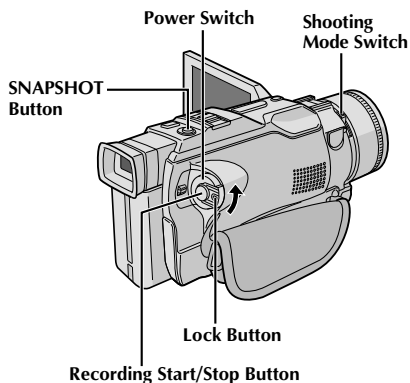

When the Recording Start/Stop Button or SNAPSHOT is pressed, the tally lamp changes as shown:

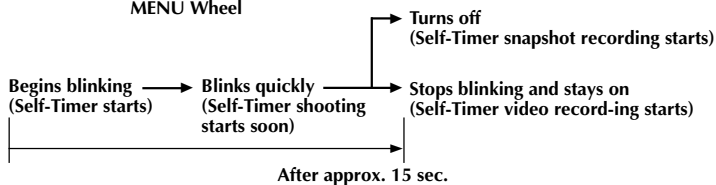
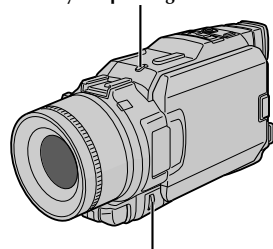

Self-Timer

Once the camcorder is set, the camcorder operator can become part of the scene in a more natural way, adding the final touch to a memorable picture.

- 1 Set the Power Switch to "M" while pressing down the Lock Button located on the switch. Pull out the viewfinder fully or open the LCD monitor fully.
 - You can tilt the LCD monitor upward to 180° so that it faces forward and view yourself while self-recording.
- 2 Press the MENU wheel. The Menu Screen appears.
- 3 Rotate the MENU wheel to select "M MANUAL", and press it.
- 4 Rotate the MENU wheel to select "SELF-TIMER", and press it. The Sub Menu appears. Rotate the MENU wheel to select "ON ☺", and press it. Selection is complete. Rotate the MENU wheel to select "◀RETURN", and press it twice to close the Menu Screen.
- 5 To engage the Self-Timer for video recording, press the Recording Start/Stop Button. After 15 seconds, the beep sounds and video recording starts. To stop Self-Timer recording, press the Recording Start/Stop Button again. The camcorder re-enters Record-Standby mode.

OR

Press SNAPSHOT. After 15 seconds, the beep sounds and snapshot recording starts. After that, the camcorder re-enters Record-Standby mode.
- 6 To end Self-Timer recording, select "OFF" in step 4.

NOTE:

If "BEEP" and "TALLY" are set to "OFF" (☞ pg. 29), the beep does not sound and the tally lamp does not light.

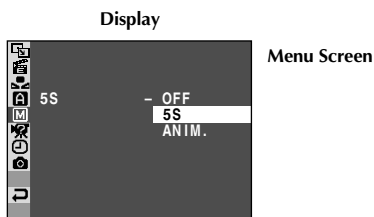
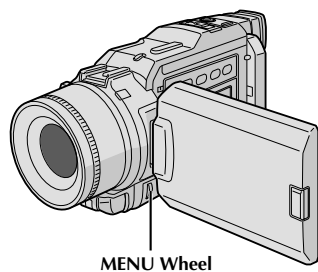
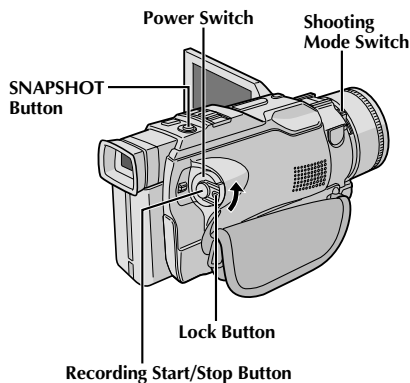

5-Second Recording

Record a vacation or an important event in 5-second clips to keep the action moving. This function is available only for video recording.

- 1** Set the Shooting Mode Switch to "VIDEO", then set the Power Switch to "M" while pressing down the Lock Button located on the switch. Pull out the viewfinder fully or open the LCD monitor fully.
- 2** Press the **MENU** wheel. The Menu Screen appears.
- 3** Rotate the **MENU** wheel to select "M MANUAL", and press it. The MANUAL Menu appears.
- 4** Rotate the **MENU** wheel to select "5S", and press it. The Sub Menu appears.
- 5** Rotate the **MENU** wheel to select "5S", and press it. Selection is complete. Rotate the **MENU** wheel to select "◀RETURN", and press it twice to close the Menu Screen.
 - "5S" appears.
- 6** Press the Recording Start/Stop Button. The tally lamp lights and beep sounds to indicate the start of recording, and after 5 seconds the camcorder enters Record-Standby mode.
 - Even if you press the Recording Start/Stop Button again within 5 seconds after recording starts, Record-Standby mode is not engaged.
- 7** To exit the 5S mode, select "OFF" in step 5.

To Take A Snapshot In The 5-Second Recording Mode . . .

.... instead of pressing the Recording Start/Stop Button in step 6, select the desired Snapshot mode in the Menu Screen, then press **SNAPSHOT**. The camcorder records a 5-second still (☞ pg. 18). When "5S" is set to "ANIM." (☞ pg. 28) this function is not available.

NOTE:

When "5S" is set to "ANIM." in the Menu Screen the 5-second recording mode is not available. Animation recording of a few frames only is taken instead (☞ pg. 28).

Fade/Wipe Effects

These effects let you make pro-style scene transitions. Use them to spice up the transition from one scene to the next. You can also vary transitions from scene to scene.

IMPORTANT:

Some Fade/Wipe Effects cannot be used with certain modes of Programme AE with special effects (pg. 34, 35). If an unusable Fade/Wipe Effect is selected, its indicator blinks or goes out.

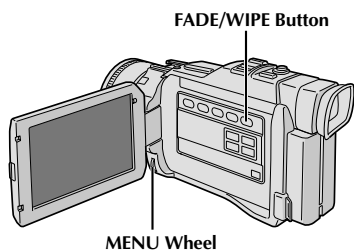
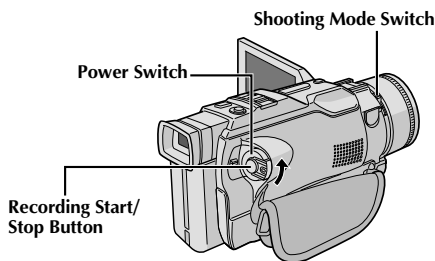

To Deactivate The Selected Effect . . .

.... press **FADE/WIPE** again in step 6 so that the effect indicator disappears.

NOTES:

- Once a Fade/Wipe Effect is executed, the effect is deactivated and its indicator goes out. To use the same effect again, press **FADE/WIPE** as required. To use a different effect, start from step 4.
- You can extend the length of a Fade or Wipe by pressing and holding the Recording Start/Stop Button.
- If the power is turned off after a scene is finished recording, the stored point is erased, disabling the Picture Wipe/Dissolve combination. When this happens, the Picture Wipe/Dissolve indicator blinks. Also note that power shuts off automatically if 5 minutes elapse in the Record-Standby mode.
- Picture Wipe/Dissolve cannot be used when "CAMERA MODE" is set to "PS-VIDEO".
- All Fade/Wipe Effects cannot be used when "CAMERA MODE" is set to "DUAL".
- The sound at the end of the last recorded scene is not stored.

FADE/WIPE SELECTION

(**W**, **BK**, **BW**, **L**, **R**, **L**, **R**, **L**, **R** and **L**)

Fade or Wipe works when video recording is started or when you stop recording.

- 1 Set the Shooting Mode Switch to "VIDEO" and set the Power Switch to "**W**" while pressing down the Lock Button located on the switch. Pull out the viewfinder fully or open the LCD monitor fully.
- 2 Press the **MENU** wheel. The Menu Screen appears.
- 3 Set "CAMERA MODE" to "VIDEO" or "PS-VIDEO" in the Menu Screen (pg. 26, 27).
- 4 Rotate the **MENU** wheel to select "**W** FADER/WIPE", then press it. Rotate the **MENU** wheel to select the desired function, then press it. Selection is complete.
- 5 Press the **MENU** wheel again. The Menu Screen closes.
- 6 **To activate the Fade-in or Wipe-in . . .**
.... Press **FADE/WIPE** during Record-Standby mode so that the selected effect indicator appears.
To activate the Fade-out or Wipe-out . . .
.... Press **FADE/WIPE** during recording so that the selected effect indicator appears.
- 7 Press the Recording Start/Stop Button to activate the Fade-in/out or Wipe-in/out.

















PICTURE WIPE OR DISSOLVE SELECTION

(**W**P, **BK**P, **BW**P, **L**P, **R**P, **L**P, **R**P and **L**P)

The Picture Wipe or Dissolve works when video recording is started.

- 1 Follow steps 1 through 5 above.
- 2 Engage the Record-Standby mode.
If you press FADE/WIPE during recording . . .
.... press the Recording Start/Stop Button when one scene is finished. The point at which the scene ended is stored in memory.
If you press FADE/WIPE during Record-Standby mode . . .
.... press the Recording Start/Stop Button to start recording and press it again when one scene is finished. The point at which the scene ended is stored in memory.
- 3 If you start recording a new scene within 5 minutes of the end of the previous recording (without having turned the camcorder's power off), the previous scene wipes out, revealing the new scene.

Fader And Wipe Menu

Menu	Effect
 FADER — WHITE	Fade in or out with a white screen.
 FADER — BLACK	Fade in or out with a black screen.
 FADER — B.W	Fade in to a colour screen from a black and white screen, or fade out from colour to black and white.
 WIPE — CORNER	Wipe in on a black screen from the upper right to the lower left corner, or wipe out from lower left to upper right, leaving a black screen.
 WIPE — WINDOW	The scene starts in the centre of a black screen and wipes in toward the corners, or comes in from the corners, gradually wiping out to the centre.
 WIPE — SLIDE	Wipe in from right to left, or wipe out from left to right.
 WIPE — DOOR	Wipe in as the two halves of a black screen open to the left and right, revealing the scene, or wipe out and the black screen reappears from left and right to cover the scene.
 WIPE — SCROLL	The scene wipes in from the bottom to the top of a black screen, or wipes out from top to bottom, leaving a black screen.
 WIPE — SHUTTER	Wipe in from the centre of a black screen toward the top and bottom, or wipe out from the top and bottom toward the centre leaving a black screen.
 P DISSOLVE	The new scene gradually appears as the old one gradually disappears.
 P WIPE — CORNER	The new scene wipes in over the previous one from the upper right corner to the lower left corner.
 P WIPE — WINDOW	The next scene gradually wipes in from the centre of the screen toward the corners, covering the previous scene.
 P WIPE — SLIDE	The next scene gradually wipes in over the previous one from right to left.
 P WIPE — DOOR	The previous scene wipes out from the centre to the right and left, like a door being pushed open to reveal the next scene.
 P WIPE — SCROLL	The new scene wipes in over the last one from the bottom of the screen to the top.
 P WIPE — SHUTTER	The new scene wipes in over the previous one from the centre toward the top and bottom of the screen.

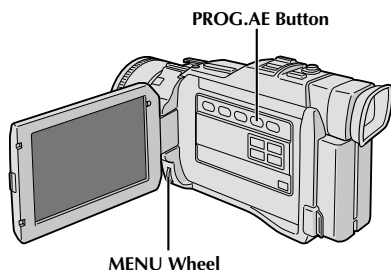
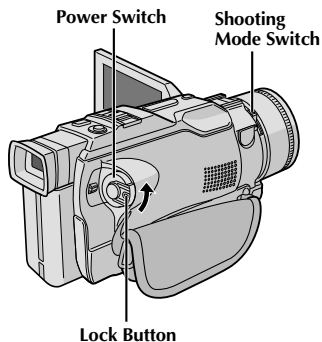

IMPORTANT:

Some modes of Programme AE with special effects cannot be used with certain Fade/Wipe Effects (pg. 33). If an unusable mode is selected, its indicator blinks or goes out.

**Display**

Menu Screen

Programme AE With Special Effects

- 1** Set the Power Switch to "  " while pressing down the Lock Button located on the switch. Pull out the viewfinder fully or open the LCD monitor fully.
- 2** Press the MENU wheel. The Menu Screen appears.
- 3** Rotate the MENU wheel to select "  PROGRAM AE", then press it.
- 4** Rotate the MENU wheel to select the desired mode, then press it. Selection is complete.
- 5** Press the MENU wheel again. The Menu Screen closes.
- 6** Press PROG.AE so that the selected effect indicator appears.

To Deactivate The Selected Mode . . .

.... press PROG.AE again so that the effect indicator disappears.

NOTE:

Programme AE with special effects can be changed during recording or during Record-Standby.

SHUTTER

1/50—The shutter speed is fixed at 1/50th of a second. Black bands that usually appear when shooting a TV screen become narrower.

1/120—The shutter speed is fixed at 1/120th of a second. The flickering that occurs when shooting under a fluorescent light or mercury-vapour lamp is reduced.



 **SPORTS**
(Variable
Shutter Speed:
1/250 – 1/4000)*¹

This setting allows fast-moving images to be captured one frame at a time, for vivid, stable slow-motion playback. The faster the shutter speed, the darker the picture becomes. Use the shutter function under good lighting conditions.



SNOW
Compensates for subjects that may otherwise appear too dark when shooting in extremely bright surroundings such as in the snow.



SPOTLIGHT
Compensates for subjects that may otherwise appear too bright when shooting under extremely strong direct lighting such as spotlights.

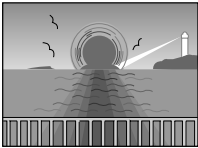

 **TWILIGHT**

Makes evening scenes look more natural. White Balance (☞ pg. 37) is initially set to , but can be changed to your desired setting. When Twilight is chosen, the camcorder automatically adjusts the focus from approx. 10 m to infinity. From less than 10 m, adjust the focus manually.



SEPIA*²
Recorded scenes have a brownish tint like old photos. Combine this with the Cinema mode for a classic look.



B/W MONOTONE*²
Like black and white films, your footage is shot in B/W. Used together with the Cinema mode, it enhances the “classic film” effect.



 **CLASSIC FILM***²

Gives recorded scenes a strobe effect.



 **STROBE***²

Your recording looks like a series of consecutive snapshots.

SLOW (Slow Shutter)*²

Lights dark subjects or areas even brighter than they would be under good natural lighting. Use “SLOW” only in dark areas.

 1 SLOW 1

Slow Shutter raises light sensitivity to allow shooting in dark environments.

 2 SLOW 2

Slow Shutter raises light sensitivity further to allow shooting in even darker environments.

NOTES:

- When using “SLOW”, the image takes on a strobe-like effect.
- If the manual focus indicator blinks when “SLOW” is used, adjust focus manually and use a tripod.



 **VIDEO ECHO***³

Adds a “ghost” to the subject, giving your recording a “fantasy” feeling. Zoom magnification of over 10X is not available.

*¹ With images shot in the UXGA mode, the shutter speed is applicable only up to 1/500 (☞ pg. 14).

*² Available when “CAMERA MODE” is set to “VIDEO” or “PS-VIDEO”.

*³ Available when “CAMERA MODE” is set to “VIDEO”.

Exposure Control

Manual exposure adjustment is recommended in the following situations:



- When shooting using reverse lighting or when the background is too bright.
- When shooting on a reflective natural background such as at the beach or when skiing.
- When the background is overly dark or the subject light.

- 1 Set the Power Switch to "M" while pressing down the Lock Button located on the switch, then pull out the viewfinder fully or open the LCD monitor fully.
- 2 Press **EXPOSURE**. The exposure control indicator appear.
- 3 Rotate the **MENU** wheel towards "▲" to brighten the image, or towards "▼" to darken the image. (maximum ± 6)
- 4 Press the **MENU** wheel. Exposure adjustment is complete.

To Return To Automatic Exposure Control . . .



.... press **EXPOSURE** or set the Power Switch to "A".

To Brighten The Subject Quickly . . .

.... press **BACKLIGHT**.  is displayed and the subject is brightened. If pressed again,  disappears and the brightness returns to the previous level.

- +4 exposure has the same effect as the **BACKLIGHT** Button.
- Using **BACKLIGHT** may cause the light around the subject to become too bright and the subject to become white.
- Backlight compensations is also available when the Power Switch is set to "A".

NOTE:

Backlight, spotlight ( pg. 35) compensation and "SNOW" ( pg. 35) have no effect when the manual Exposure Control mode is engaged.



Iris Lock

Use this function in the following situations:

- When shooting a moving subject.
- When the distance to the subject changes (so its size in the LCD monitor or the viewfinder changes), such as when the subject is backing away.
- When shooting on a reflective natural background such as at the beach or when skiing.
- When shooting objects under a spotlight.
- When zooming.

When the subject is close, keep the iris locked. Even when the subject moves away from you, the image will not darken or brighten.

Before the following steps, perform steps 1 and 2 of "Exposure Control".

- 3 Adjust zoom so that the subject fills the LCD monitor or the viewfinder, then press and hold the **MENU** wheel for over 2 seconds. The exposure control indicator and "" appear. Press the **MENU** wheel. "" changes to "" and the iris is locked.

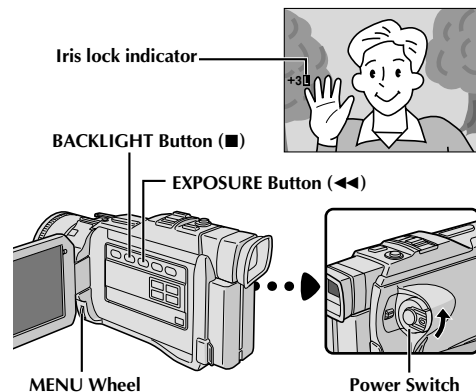

To Return To Automatic Iris Control . . .

.... press **EXPOSURE** so that the exposure control indicator and "" disappear. Or, set the Power Switch to "A".

To Lock The Exposure Control And The Iris . . .

.... after step 2 of "Exposure Control", adjust the exposure rotating the **MENU** wheel. Then lock the iris in step 3 of "Iris Lock". For automatic locking, press **EXPOSURE** again in step 2. The iris becomes automatic after about 2 seconds.

Iris

Like the pupil of the human eye, it contracts in well-lit environments to keep too much light from entering, and dilates in dim environments to allow in more light.

White Balance Adjustment

A term that refers to the correctness of colour reproduction under various lighting. If the white balance is correct, all other colours will be accurately reproduced. The white balance is usually adjusted automatically. However, more advanced camcorder operators control this function manually to achieve a more professional colour/tint reproduction.

- 1** Set the Power Switch to "M" while pressing down the Lock Button located on the switch, then pull out the viewfinder fully or open the LCD monitor fully.
- 2** Press the **MENU** wheel. The Menu Screen appears.
- 3** Rotate the **MENU** wheel to select "W.BALANCE", then press it. The W.BALANCE Menu appears.
- 4** Rotate the the **MENU** wheel to select the desired mode.

"AUTO"	– White balance is adjusted automatically (factory preset).
"MWB"	– White balance is set manually.
"FINE"	– Outdoors on a sunny day.
"CLOUD"	– Outdoors on a cloudy day.
"HALOGEN"	– A video light or similar type of lighting is used.
- 5** Press the **MENU** wheel. Selection is complete. Press the **MENU** wheel again. The Menu Screen closes and the selected mode indicator except "AUTO" appears.

To Return To Automatic White Balance . . .

.... select "AUTO" in step 4. Or, set the Power Switch to "A".

NOTE:

White balance cannot be used when Sepia or Monotone (pg. 35) is activated.

Manual White Balance Operation

Perform Manual White Balance when shooting under various types of lighting.

- 1** Follow steps 1 through 4 of the white balance adjustment, and select "MWB".
- 2** Hold a sheet of plain white paper in front of the subject. Adjust zoom or position yourself so that the white paper fills the screen.
- 3** Press the **MENU** wheel until the MWB icon begins blinking rapidly. When the setting is completed, the MWB icon resumes normal blinking.
- 4** Press the **MENU** wheel. The Menu Screen closes and the Manual White Balance indicator MWB is displayed.

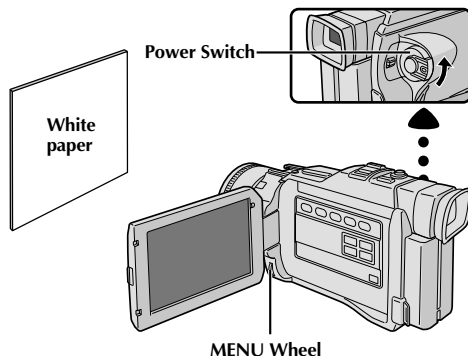

To Change The Tint For Recording . . .

.... in step 2, substitute coloured paper for white.

The white balance is adjusted based on the colour, changing the tint. Red paper = deeper green; blue paper = orange; yellow paper = deeper purple.

NOTES:

- In step 2, it may be difficult to focus on the white paper. In such a case, adjust focus manually (pg. 25).
- A subject can be shot under various types of lighting conditions indoors (natural, fluorescent, candlelight, etc.). Because the colour temperature is different depending on the light source, the subject tint will differ depending on the white balance settings. Use this function for a more natural result.
- Once you adjust white balance manually, the setting is retained even if the power is turned off or the battery removed.

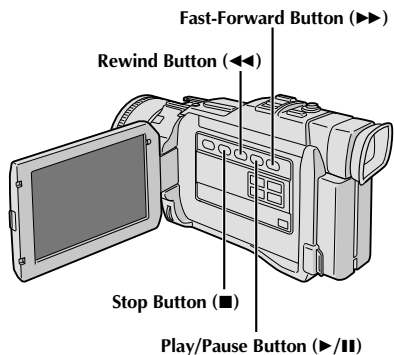
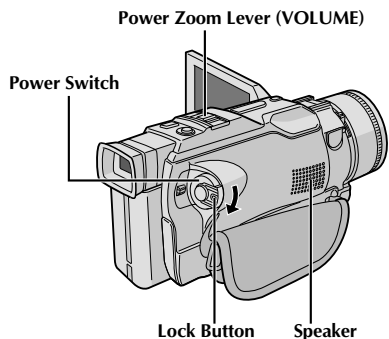

1 Load a tape (☞ pg. 10).



2 Set the Power Switch to “PLAY” while pressing down the Lock Button located on the switch. To start playback, press ▶/||.

- To stop playback, press ■.
- Press ◀◀ to rewind, or ▶▶ to fast-forward the tape during Stop mode.

To Control The Speaker Volume . . .

.... slide the Power Zoom Lever (VOLUME) towards “+” to turn up the volume, or towards “-” to turn down the volume.

NOTES:

- If Stop mode continues for 5 minutes when power is supplied from a battery, the camcorder shuts off automatically. To turn on again, set the Power Switch to “OFF”, then to “PLAY”.
- The playback picture can be viewed in the LCD monitor, viewfinder or on a connected TV (☞ pg. 52).
- You can also view the playback picture on the LCD monitor with it flipped over and pushed against the camera body.
- LCD monitor/viewfinder indications:
 - When power is supplied from a battery: the “” battery pack remaining power indicator is displayed. When power is supplied through the DC cord: “” does not appear.
 - During Stop mode, none of the indications are displayed.
- When a cable is connected to the AV connector, the sound is not heard from the speaker.

Still Playback:

Pauses during playback.

- 1) Press ▶/|| during playback.
 - 2) To resume normal playback, press ▶/|| again.
- If still playback continues for more than about 3 minutes, the camcorder’s Stop mode is automatically engaged. After 5 minutes in the Stop mode, the camcorder’s power is automatically turned off.
 - When ▶/|| is pressed, the image may not pause immediately while the camcorder stabilises the still image.

Shuttle Search:

Allows high-speed search in either direction.

- 1) Press ▶▶ for forward or ◀◀ for reverse search during playback.
 - 2) To resume normal playback, press ▶/||.
- During playback, press and hold ◀◀ or ▶▶. The search continues as long as you hold the button. Once you release it, normal playback resumes.
 - A slight mosaic effect appears on screen during Shuttle Search. This is not a malfunction.

Frame-By-Frame Playback:

Allows frame-by-frame search.

- 1) Engage Still Playback.
 - 2) Rotate the MENU wheel towards “▲” for forward Frame-By-Frame Playback, or towards “▼” for reverse Frame-By-Frame Playback during Still Playback.
- To resume normal playback, press ▶/||.
 - You can also use the provided remote control for Frame-By-Frame Playback (☞ pg. 63).

Slow-Motion Playback, Playback Zoom and Playback Special Effects

Available only with the remote control (☞ pg. 63, 64).

Using Menus For Detailed Adjustment

The following procedure applies to all except *Synchro Comp* (☞ pg. 69, 70).

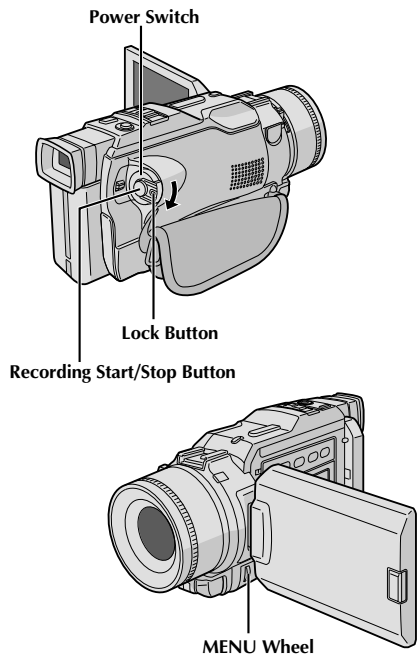

- 1** Set the Power Switch to "PLAY" while pressing down the Lock Button located on the switch.
- 2** Press the MENU wheel. The Menu Screen appears.
- 3** Rotate the MENU wheel to select the desired function menu, and press it. The selected function menu appears.
- 4** Rotate the MENU wheel to select the desired function, and press it to display the Sub Menu.
- 5** Rotate the MENU wheel to select the desired parameter and press it. Selection is complete.
- 6** Rotate the MENU wheel to select "◀RETURN" and press it twice to close the Menu Screen.

Display

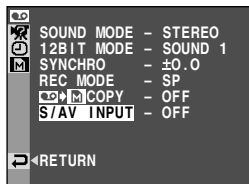

Menu Screen

* Each setting is linked with "DISPLAY" or "SYSTEM", which appears when the Power Switch is set to "M" (☞ pg. 29). The parameters are the same as in the description on pg. 29.

NOTES:

- It is also possible to change the ON SCREEN settings by pressing **DISPLAY** on the remote control.
- "REC MODE" can be set when the Power Switch is set to "PLAY" or "M" (☞ pg. 13, 27).
- When "S/AV INPUT" is set to "ON", camcorder playback cannot be viewed on the AV output.

VIDEO	SOUND MODE	☞ pg. 40.
	12BIT MODE	☞ pg. 40.
	SYNCHRO	☞ pg. 70.
	REC MODE	Allows you to set the video recording mode (SP or LP) depending on your preference (☞ pg. 13). It is recommended you use "REC MODE" in the "VIDEO" Menu when using this camcorder as a recorder during dubbing (☞ pg. 57, 59).
VIDEO	COPY	ON: Enables dubbing of images recorded on a tape to a memory card (☞ pg. 60). OFF: Enables snapshots to be taken during video playback.
	S/AV INPUT	ON: Enables audio/video signal input from the AV and S-VIDEO connectors (☞ pg. 57). OFF: Enables audio/video signal output to a TV, VCR, etc. via the AV and S-VIDEO connectors (☞ pg. 52, 56).
SYSTEM	BEEP*	Makes a beep or melody sound/activates the shutter sound effect.
	TALLY*	Turns on/off the tally lamp.
	DEMO MODE*	Starts automatic demonstration.
DISPLAY	ON SCREEN*	Makes the camcorder's indications appear/disappear from the connected TV screen.
	DATE/TIME*	Makes the date/time appear/disappear on the camcorder.
	TIME CODE*	Makes the time code appear/disappear on the camcorder.

Playback Sound

During video playback, the camcorder detects the sound mode in which the recording was made, and plays the sound back. Select the type of sound to accompany your playback picture. According to the menu access explanation on pg. 39, select "SOUND MODE" or "12BIT MODE" from the Menu Screen and set it to the desired parameter.

SOUND MODE	STEREO	Sound is output on both "L" and "R" channels in stereo.
	SOUND L	Sound from the "L" channel is output in stereo.
	SOUND R	Sound from the "R" channel is output in stereo.
12BIT MODE	SOUND 1	Original sound is output on both "L" and "R" channels in stereo.
	SOUND 2	Dubbed sound is output on both "L" and "R" channels in stereo.
	MIX	Original and dubbed sounds are combined and output in stereo on both "L" and "R" channels in stereo.

 : Factory-preset

NOTES:

- The "SOUND MODE" setting is available for both 12-bit and 16-bit sound. (In previous models' functions, "12-bit" is called "32 kHz" and "16-bit" is called "48 kHz".)
- The camcorder cannot detect the sound mode in which the recording was made during fast-forward or rewind. During playback the sound mode is displayed in the upper left corner.

Display

ON SCREEN setting:
For playback sound, tape speed and tape running.

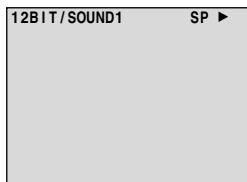

DATE/TIME setting:
For date/time.

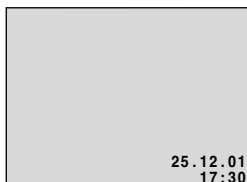

TIME CODE setting:
For time code.

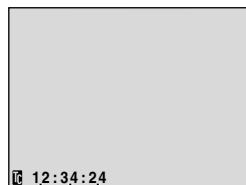

Minutes
Seconds
Frames*

*25 frames = 1 second

Power Switch

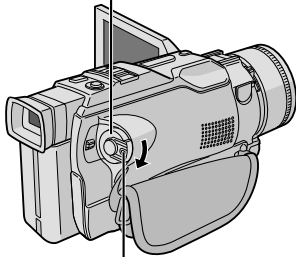

Lock Button

Stop Button (■)

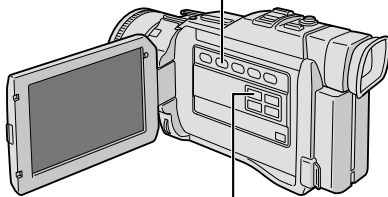

BLANK SEARCH Button

Display



Blank Search

Helps you find where you should start recording in the middle of a tape to avoid time code interruption (☞ pg. 21).

1 Load a tape (☞ pg. 10) and set the Power Switch to "PLAY" while pressing down the Lock Button located on the switch.

2 Press **BLANK SEARCH**.
 • "BLANK SEARCH" appears blinking and the camcorder automatically starts reverse or forward shuttle search, then stops at the spot which is about 3 seconds of tape before the beginning of the detected blank portion.

To cancel Blank Search midway . . .

.... press ■.

NOTES:

- In step 2, if the current position is at a blank portion the camcorder searches in the reverse direction, and if the current position is at a recorded portion the camcorder searches in the forward direction.
- Blank Search does not work if "HEAD CLEANING REQUIRED. USE CLEANING CASSETTE" has appeared with the tape.
- If the beginning or end of the tape is reached during Blank Search, the camcorder stops automatically.
- A blank portion which is shorter than 5 seconds of tape cannot be detected.
- The detected blank portion may be located between recorded scenes. Before you start recording, make sure there is no recorded scene after the blank portion.

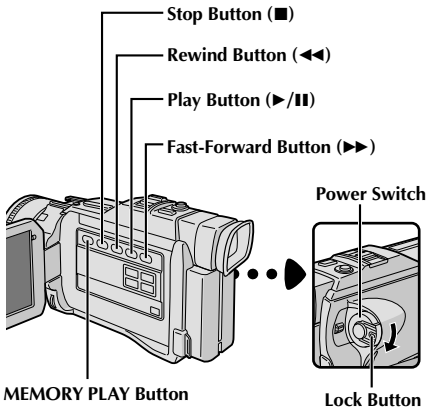

Normal Playback

Images shot with the camcorder are automatically numbered, then stored in numerical order in the memory card. You can view the stored images, one at a time, much like flipping through a photo album.

- 1 Load a memory card (☞ pg. 11).
- 2 Set the Power Switch to "PLAY" while pressing down the Lock Button. Open the LCD monitor fully or pull out the viewfinder fully.
- 3 Press MEMORY PLAY.
 - A stored image is displayed.
- 4 Press ▶▶ to display the next image.
Press ◀◀ to display the previous image.

[For Normal Playback]

To display the next image

[For Auto Playback]

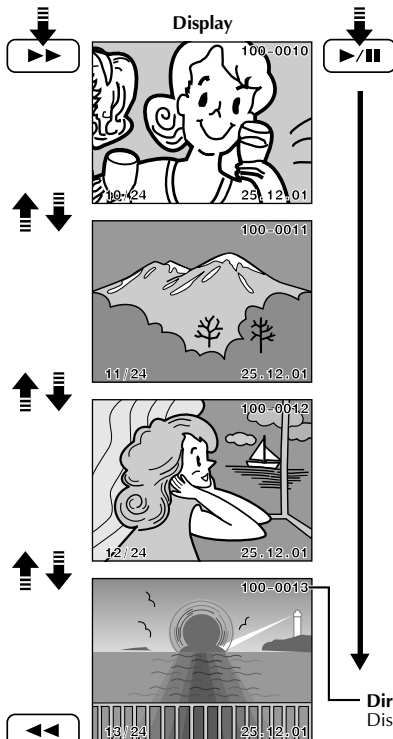

To display the previous image

Total number of images

Displays the total number of stored images.

Image number

Displays the index number of the image file (☞ pg. 43).

Directory and File names

Displays the directory and file names (☞ pg. 43).

Auto Playback

You can run through all the images stored in memory automatically.

- 1 Perform steps 1 through 3 above.
- 2 Press ▶/||.
 - If you press ◀◀ during Auto Playback, images are displayed in descending order.
 - If you press ▶▶ during Auto Playback, images are displayed in ascending order.
- 3 To end Auto Playback, press ■.

NOTE:

Even if you shoot a new image after playing back a low-numbered one, this will not overwrite an existing image, because new images are automatically stored after the last-recorded one.

Index Screen

The images you shot can be displayed together with their index information. Convenient for checking images shot beforehand, the Index Screen also shows the Picture quality, directory and file names as well as which images are protected against accidental erasure.

100-DVC0003: Directory and File names

Shows that the selected shot is in a directory called "100" and its file name is "DVC00003".

Each time shooting takes place, a file name is made using a number which is larger by one than the largest number of the file names which are in use. If the file name reaches DVC09999, a new directory will be made and the file name will start again from DVC00001.

In the playback screen (☞ pg. 42), the directory and only the last four digits of the file name are displayed.

VGA: File size

Displays the file size of the stored image. There are 3 modes available: UXGA, XGA and VGA (☞ pg. 14).

001: Index number

Index numbers are marked from 001. For example, when 10 images are stored (index number: 001 to 010), if three images with index numbers 002, 004 and 006 are deleted from memory, the remaining images are automatically moved up to fill any gaps in the numerical sequence. Therefore, the number of remaining images is 7, and the new index numbers range from 001 to 007.

F/S: Picture Quality

Displays the quality of the stored image. There are 2 modes available: FINE and STANDARD (in order of quality) (☞ pg. 14).

🔒: Protect icon

When an image is protected against its accidental erasure, a padlock mark appears next to the Picture Quality indicator, and that image cannot be deleted.

Selected Image

An image is framed in green when it is selected. Rotate the MENU wheel to move the green frame to the desired image.

Index Playback

You can view the images stored in memory six at a time. Use this mode when looking for an image you wish to view.

- 1** Perform steps 1 through 3 of "Normal Playback" on pg. 42.
- 2** To access the Index Screen, press **INDEX**.
- 3** Rotate the **MENU** wheel to move the green frame to the desired image and press it. The image selected in the Index Screen is displayed.

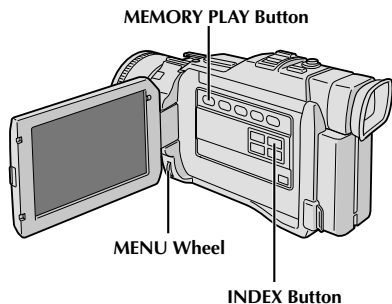
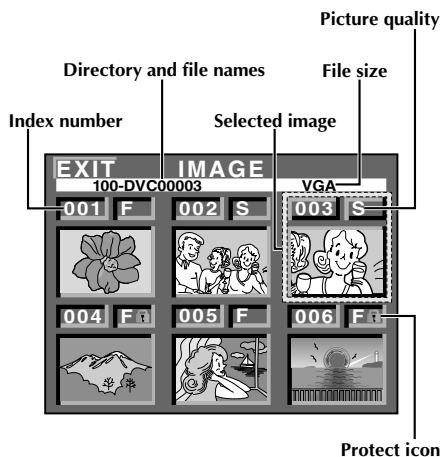

Playback Screen

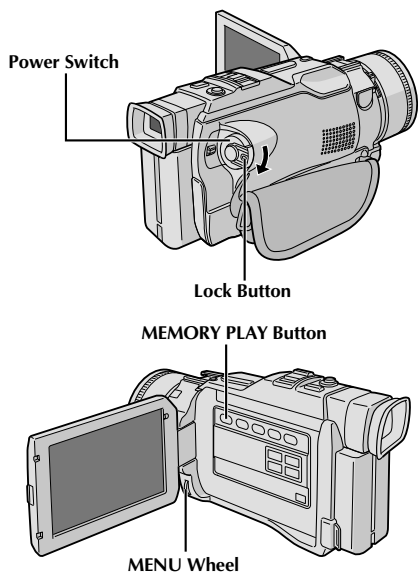

Display

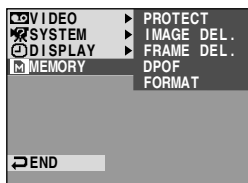

Menu Screen

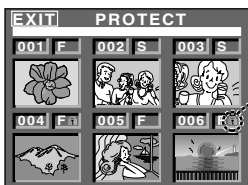

PROTECT Index Screen



Padlock mark

Normal playback

If Protection is removed



Normal playback

Protecting Images

The Protect mode helps prevent the accidental erasure of images. When a padlock mark is displayed next to the Picture Quality indication, that image cannot be deleted.

- 1** Set the Power Switch to "PLAY" while pressing down the Lock Button. Open the LCD monitor fully or pull out the viewfinder fully.
- 2** Press **MEMORY PLAY**.
 - A stored image is displayed.
- 3** Press the **MENU** wheel. The Menu Screen appears. Press the **MENU** wheel again. The MEMORY Menu appears.
- 4** Rotate the **MENU** wheel to select "PROTECT" and press it. The PROTECT Index Screen appears.

TO PROTECT AN IMAGE

Before doing the following, perform steps 1 through 4 above.

- 5** Rotate the **MENU** wheel to move the green frame to the desired image and press it. A "🔒" padlock mark appears on the selected image. Repeat this procedure for all images you do not wish to delete by accident.
- 6** Rotate the **MENU** wheel upward to select "EXIT" and press it. The normal playback screen appears.

NOTE:

When the memory is initialised or corrupted, even protected images are deleted. If you do not want to lose important images, transfer them to a PC and save them.

TO REMOVE PROTECTION

Before doing the following, perform steps 1 through 4 above.

- 5** Rotate the **MENU** wheel to move the green frame to the desired image and press it. The "🔒" padlock mark located above the image disappears and the image is no longer protected. Repeat this procedure for all images from which you wish to remove protection.
- 6** Rotate the **MENU** wheel upward to select "EXIT" and press it. The normal playback screen appears.

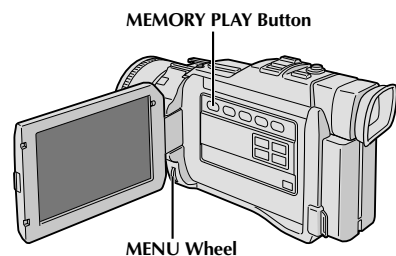

Display

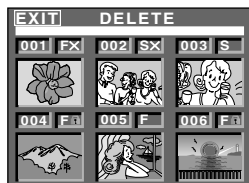

DELETE Index Screen

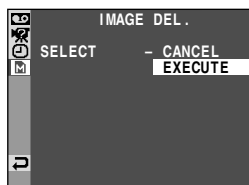

Deletion Confirmation Screen

CAUTION:

Do not remove the memory card or perform any other operation (such as turning off the camcorder) during deletion. Also, be sure to use the provided AC Power Adapter/Charger, as the memory card may be corrupted if the battery becomes exhausted during deletion. If the memory card becomes corrupted, initialise it. (pg. 47)

NOTES:

- Protected images (pg. 44) cannot be deleted with the above operation. To delete them, remove protection first.
- Once images are deleted, they cannot be restored. Check images before deleting.

Deleting Images

Previously shot images can be deleted either one at a time or all at once.

- 1 Perform steps 1 through 3 of "Protecting Images" on pg. 44.
- 2 Rotate the **MENU** wheel to select "IMAGE DEL." and press it. The Sub Menu appears.

TO DELETE THE DISPLAYED IMAGE

Before doing the following, perform steps 1 and 2 above.

- 3 Rotate the **MENU** wheel to select "CURRENT" and press it. The Deletion Confirmation Screen appears.
- 4 Rotate the **MENU** wheel to select "EXECUTE" and press it. The currently displayed image is deleted.
 - To cancel deletion, rotate the **MENU** wheel to select "CANCEL" and press it.

TO SELECT AN IMAGE BY BROWSING IMAGES STORED IN MEMORY

Before doing the following, perform steps 1 and 2 above.

- 3 Rotate the **MENU** wheel to select "SELECT" and press it. The DELETE Index Screen appears.
- 4 Rotate the **MENU** wheel to move the green frame to the desired image that you wish to delete and press it. An "X" appears above the selected image. Repeat this procedure for all images that you wish to delete. To deselect an image, press the **MENU** wheel again. The "X" disappears.
- 5 Rotate the **MENU** wheel upward to select "EXIT" and press it. The Deletion Confirmation Screen appears.
- 6 Rotate the **MENU** wheel to select "EXECUTE" and press it. The selected images are deleted and the normal playback screen appears.
 - To cancel deletion, rotate the **MENU** wheel to select "CANCEL" and press it.

TO DELETE ALL IMAGES

Before doing the following, perform steps 1 and 2 above.

- 3 Rotate the **MENU** wheel to select "ALL" and press it. The Deletion Confirmation Screen appears.
- 4 Rotate the **MENU** wheel to select "EXECUTE" and press it. All the images are deleted.
 - To cancel deletion, rotate the **MENU** wheel to select "CANCEL" and press it.

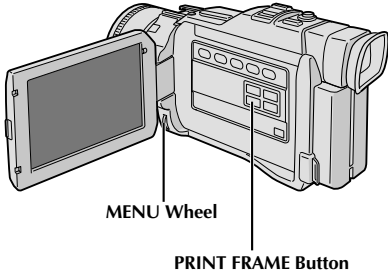

Display

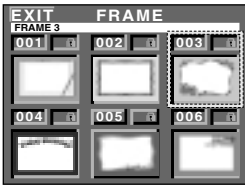
Print Frame
Index Screen

Superimposing A Print Frame

A selection of print frames are stored in the camcorder. A frame can be superimposed over a still image.

- 1 Play back an image stored in the memory card.
- 2 Press **PRINT FRAME**. The Print Frame Index Screen appears.
- 3 Rotate the **MENU** wheel to move the green frame to the desired print frame and press it. Selection is complete. The selected print frame is superimposed over the still image.

To Make The Print Frame Disappear . . .
.... press **PRINT FRAME**.

NOTES:

- A print frame created on a PC can be transferred to a memory card using the provided software. Transferred print frames are displayed from print frame index number 007, and they can be used together with the print frames in the camcorder's memory. For details on creating/transferring print frames, refer to the software instructions.
- Depending on the images you play back, the print frame outline may become grainy or vague.

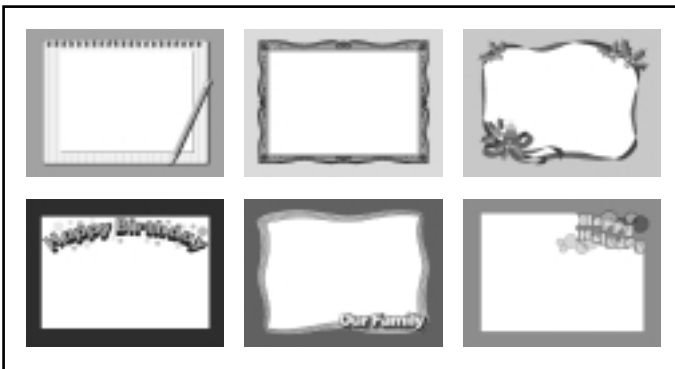

Power Switch

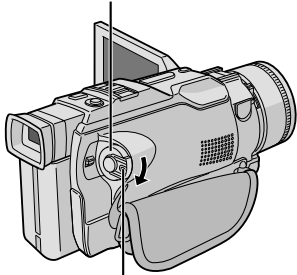

Lock Button

MEMORY PLAY Button

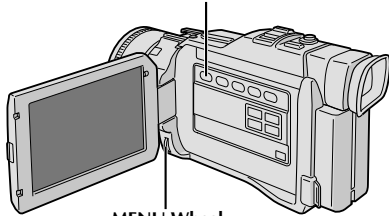

MENU Wheel

Display

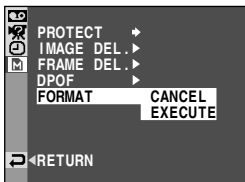

Menu Screen

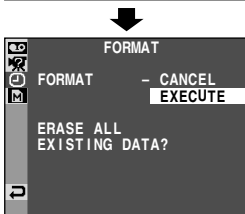

Initialising A Memory Card

You can initialise a memory card anytime. **After initialising, all images and data stored in the memory card, including those which have been protected, are cleared.**

- 1** Set the Power Switch to "PLAY", while pressing down the Lock Button located on the switch. Open the LCD monitor fully or pull out the viewfinder fully.
- 2** Press MEMORY PLAY.
- 3** Press the MENU wheel. The Menu Screen appears.
- 4** Press the MENU wheel again. The MEMORY Menu appears.
- 5** Rotate the MENU wheel to select "FORMAT" and press it. The Confirmation Screen appears.
- 6** Rotate the MENU wheel to select "EXECUTE" and press it. The memory card is initialised. When initialisation is finished, "NO IMAGES STORED" appears.
 - To cancel initialisation, rotate the MENU wheel to select "CANCEL" and press it.

CAUTION:

Do not perform any other operation (such as turning off the camcorder) during initialisation. Also, be sure to use the provided AC Power Adapter/Charger, as the memory card may be corrupted if the battery becomes exhausted during initialisation. If the memory card becomes corrupted initialise it.

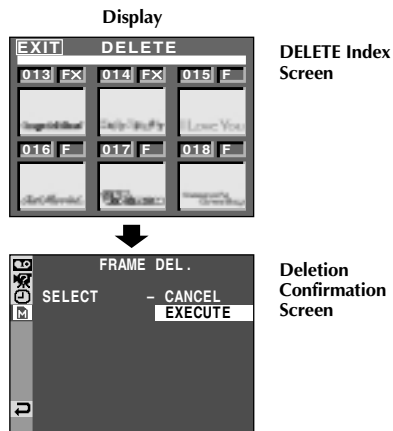
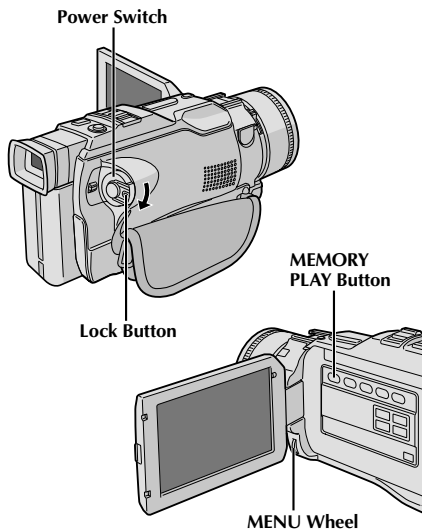

Print Frame Deletion

A print frame created on a PC can be transferred to a memory card using the provided software. Print frames that have been transferred to a memory card can be deleted when they are no longer needed.

There are 2 ways of deleting previously created print frames: by browsing through print frames individually or by deleting them all at once.

TO SELECT A PRINT FRAME BY BROWSING PRINT FRAMES STORED IN MEMORY

- 1 Set the Power Switch to "PLAY", while pressing down the Lock Button located on the switch. Open the LCD monitor fully or pull out the viewfinder fully.
- 2 Press **MEMORY PLAY**.
- 3 Press the **MENU** wheel. The Menu Screen appears.
- 4 Press the **MENU** wheel again. The MEMORY Menu appears.
- 5 Rotate the **MENU** wheel to select "FRAME DEL." and press it. The Sub Menu appears.
- 6 Rotate the **MENU** wheel to select "SELECT" and press it. The DELETE Index Screen appears.
- 7 Rotate the **MENU** wheel to move the green frame to the desired print frame that you wish to delete and press it. An "X" appears above the selected print frame.
Repeat this procedure for all print frames that you wish to delete.
To deselect a print frame, press the **MENU** wheel again. The "X" disappears.
- 8 Rotate the **MENU** wheel upward to select "EXIT" and press it. The Deletion Confirmation Screen appears.
- 9 Rotate the **MENU** wheel to select "EXECUTE" and press it. The selected print frames are deleted and the normal playback screen appears.
 - To cancel deletion, rotate the **MENU** wheel to select "CANCEL" and press it.

CAUTION:

Do not remove the memory card or perform any other operation (such as turning off the camcorder) during deletion. Also, be sure to use the provided AC Power Adapter/Charger, as the memory card may be corrupted if the battery becomes exhausted during deletion. If the memory card becomes corrupted, initialise it.

(pg. 47)

NOTES:

- If print frames created on a PC have not been transferred to a memory card, it is not possible to delete them using these steps.
- The print frames in the camcorder's memory cannot be deleted.

MEMORY PLAY Button

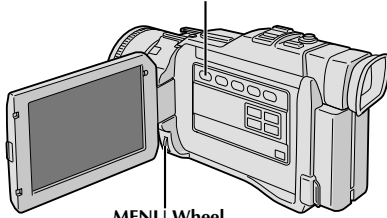

MENU Wheel

TO DELETE ALL PRINT FRAMES

- 1** Perform steps 1 through 5 on pag. 48.
- 2** Rotate the **MENU** wheel to select "ALL" and press it. The Deletion Confirmation Screen appears.
- 3** Rotate the **MENU** wheel to select "EXECUTE" and press it. All the print frames are deleted.
 - To cancel deletion, rotate the **MENU** wheel to select "CANCEL" and press it.

Display

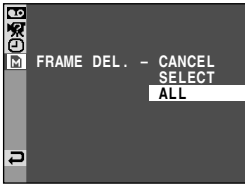

Menu Screen

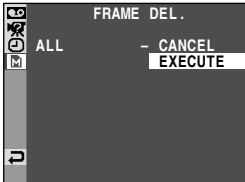

Deletion Confirmation Screen

Power Switch

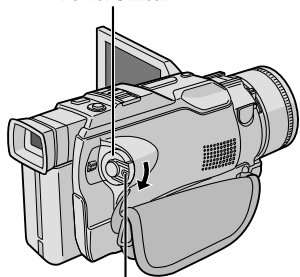

Lock Button

MEMORY PLAY Button

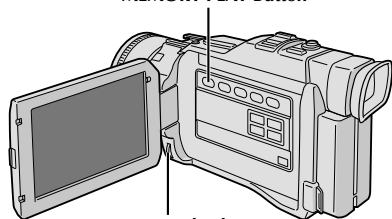

MENU Wheel

Display



Menu Screen

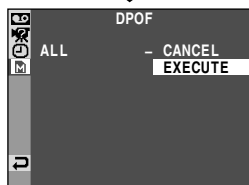

Confirmation Screen

Setting Print Information (DPOF Setting)

This camcorder is compatible with the DPOF (Digital Print Order Format) standard in order to support future systems such as automatic printing, which records information about the still images you wish to print (such as the number of prints to make). There are 2 print information settings available: "To print all still images (one print for each)" explained below and "To print by selecting still images and no. of prints" (☞ pg. 51).

TO PRINT ALL STILL IMAGES (ONE PRINT FOR EACH)

- 1** Set the Power Switch to "**PLAY**", while pressing down the Lock Button located on the switch. Open the LCD monitor fully or pull out the viewfinder fully.
- 2** Press **MEMORY PLAY**.
- 3** Press the **MENU** wheel. The Menu Screen appears.
- 4** Press the **MENU** wheel again. The MEMORY Menu appears.
- 5** Rotate the **MENU** wheel to select "DPOF" and press it. The Sub Menu appears.
- 6** Rotate the **MENU** wheel to select "ALL" and press it. Selection is complete. The Confirmation Screen appears.
- 7** Rotate the **MENU** wheel to select "EXECUTE" and press it. The normal playback screen appears.
 - To cancel selection, rotate the **MENU** wheel to select "CANCEL" and press it.

To Reset The Setting . . .

.... select "RESET" in step 6. The setting is reset to 0 for all still images.

MEMORY PLAY Button

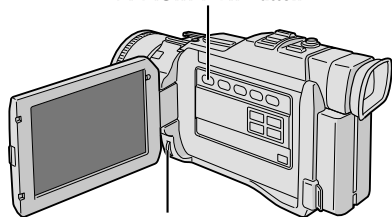

MENU Wheel

Display

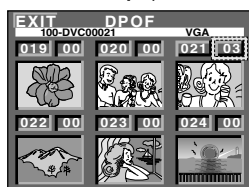

DPOF Screen

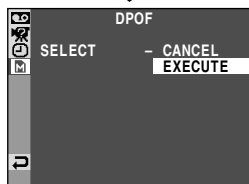

Confirmation Screen

TO PRINT BY SELECTING STILL IMAGES AND NO. OF PRINTS

- 1** Perform steps 1 through 5 on pg. 50.
- 2** Rotate the **MENU** wheel to select "SELECT" and press it. Selection is complete. The DPOF Screen appears.
- 3** Rotate the **MENU** wheel to move the green frame to the image you wish to print and press it.
- 4** Select the number of prints by rotating the **MENU** wheel towards "▲" to increase the number, or towards "▼" to decrease the number and press it. Repeat steps 3 and 4 for the desired number of prints.
 - The number of prints can be set up to 15.
 - To correct the number of prints, select the image again and change the number.
- 5** Rotate the **MENU** wheel upward to select "EXIT" and press it. Selection is complete. The Confirmation Screen appears.
- 6** Rotate the **MENU** wheel to select "EXECUTE" and press it. The normal playback screen appears.
 - To cancel selection, rotate the **MENU** wheel to select "CANCEL" and press it.

To Reset The No. Of Prints . . .

.... select "RESET" in step 6 on pg. 50. The number of prints is reset to 0 for all still images.

CAUTION:

While performing the above, never disconnect power, as this may cause the memory to be corrupted. For safety, all buttons including the Power Switch are disabled in step 5.

NOTES:

- If you load a memory card already set as shown above in a printer compatible with DPOF, it will make prints of the selected still images automatically.
- To print images recorded on a tape, first dub them to a memory card (☞ pg. 60).

These are some basic types of connections. When making the connections, refer also to your VCR and TV instruction manuals.

A. Connection to a TV or VCR equipped with an S-VIDEO IN and A/V input connectors

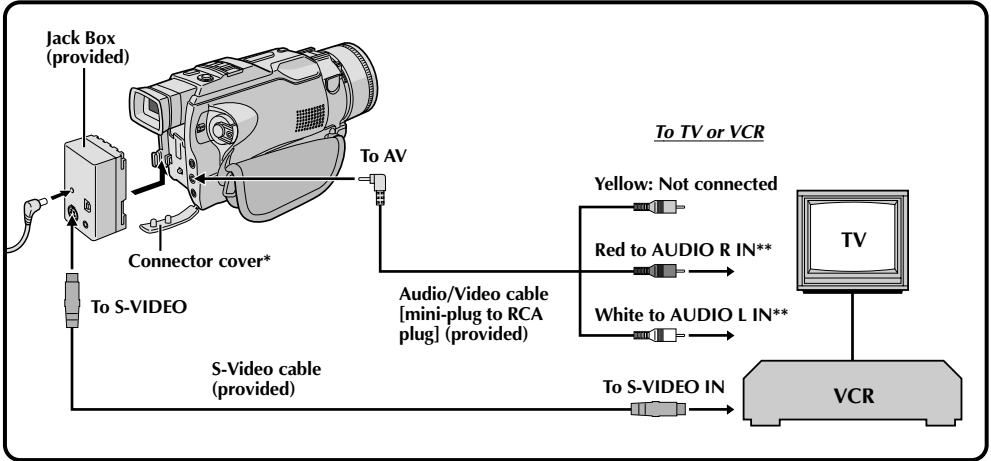

* When connecting the cables, open this cover.

** The Audio cable is not required for watching still images only.

B. Connection to a TV or VCR equipped only with A/V input connectors

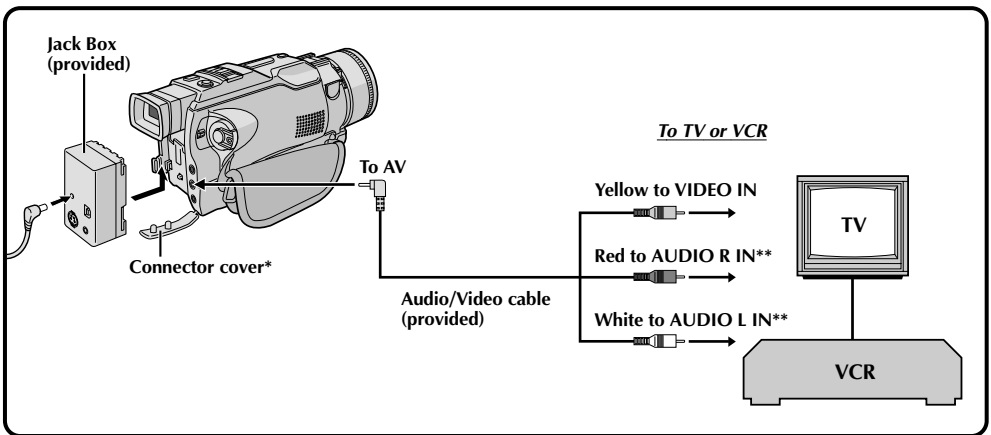

* When connecting the cables, open this cover.

** The Audio cable is not required for watching still images only.

- 1** Make sure all units are turned off.

- 2** Connect the camcorder to a TV or VCR as shown in the illustration (☞ pg. 52).
*If using a VCR . . . go to step 3.
If not . . . go to step 4.*

- 3** Connect the VCR output to the TV input, referring to your VCR's instruction manual.

- 4** Turn on the camcorder, the VCR and the TV.

- 5** Set the VCR to its AUX input mode, and set the TV to its VIDEO mode.

To choose whether or not the following displays appear on the connected TV . . .

- Date/Time
.... set "DATE/TIME" to "AUTO", "ON" or "OFF" in the Menu Screen (☞ pg. 39).
- Time Code
.... set "TIME CODE" to "ON" or "OFF" in the Menu Screen (☞ pg. 39).
- Playback Sound Mode, Tape Speed And Tape Running Displays for video playback
Or
Directory/File Names and Image Number/Total Number of Images for D.S.C. Playback
.... set "ON SCREEN" to "LCD" or "LCD/TV" in the Menu Screen (☞ pg. 39).
Or, press **DISPLAY** on the remote control.

NOTES:

- ***It is recommended to use the AC Power Adapter/Charger as the power supply instead of the battery pack*** (☞ pg. 7).
- *To monitor the picture and sound from the camcorder without inserting a tape or memory card, set the camcorder's Power Switch to "A" or "M", then set your TV to the appropriate input mode.*
- *Make sure you adjust the TV sound volume to its minimum level to avoid a sudden burst of sound when the camcorder is turned on.*
- *If you have a TV or speakers that are not specially shielded, do not place the speakers adjacent to the TV as interference will occur in the camcorder playback picture.*
- *If no image is displayed or no sound is heard from the TV, set "S/AV INPUT" to "OFF" in the Menu Screen (☞ pg. 39).*

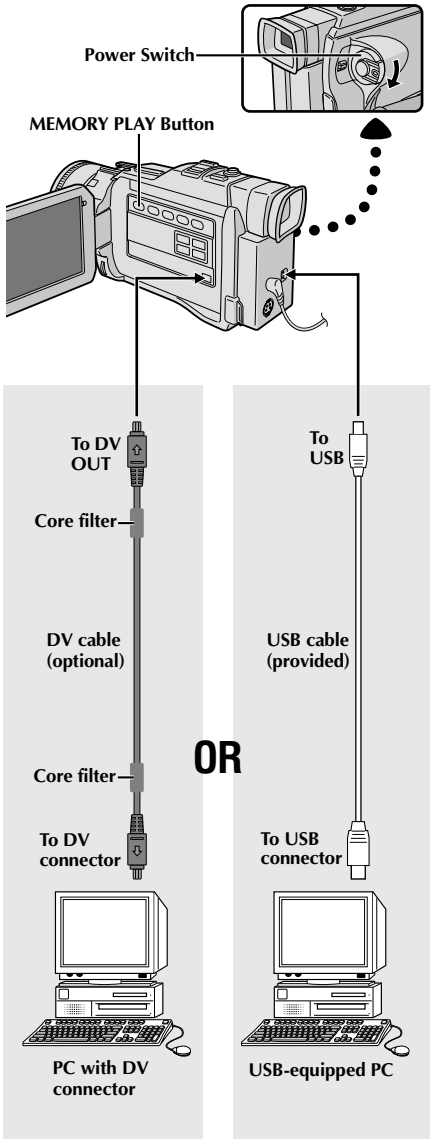

Connection To A Personal Computer

This camcorder can transfer still images to a PC via DV or USB connection as shown in the illustration.

- 1** Make sure the camcorder and PC are turned off.
- 2** Connect the camcorder to your PC using the appropriate cable as shown in the illustration.
- 3** Turn the camcorder's Power Switch to "PLAY" while pressing down the Lock Button located on the switch and turn on the PC.
If you have connected via the USB cable ... go to step 4.
- 4** Press **MEMORY PLAY**.
 - "USB MODE ACCESSING FILE" appears on the LCD monitor.
 - If the PC connected to the camcorder via the USB cable is not powered, the camcorder does not enter the USB mode.
- 5** When finished, turn off the PC first, then the camcorder.

NOTES:

- *It is recommended to use the AC Power Adapter/Charger as the power supply instead of the battery pack (pg. 7).*
- *Never connect the USB cable and the DV cable simultaneously to the camcorder. Connect only the cable you wish to use to the camcorder.*
- *The date/time information cannot be captured into the PC.*
- *Refer to the instruction manuals of the PC and provided Software.*
- *The still images can also be transferred to a PC with a DV connector-equipped capture board.*
- *When using a DV cable, be sure to use the optional JVC VC-VDV206U or VC-VDV204U DV cable depending on the type of DV connector (4 or 6 pins) on the PC, or use the DV cable provided with the capture board.*

Never disconnect the USB cable while "ACCESSING FILE" is displayed on the LCD monitor since this can result in product damage.

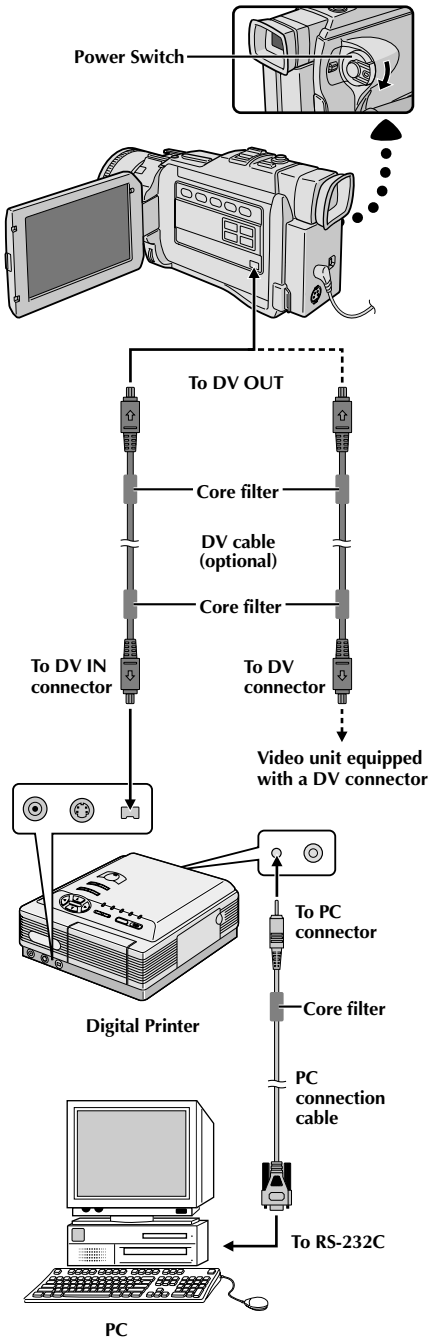

Connection To A Video Unit Equipped With A DV Connector

Connection to the GV-DT3 Digital Printer (optional) allows you to print out images or transfer them to a PC. It is also possible to copy recorded scenes from the camcorder onto another video unit equipped with a DV connector. This function is called Digital Dubbing (☞ pg. 58), which offers virtually no image or sound deterioration.

- 1 Make sure all units are turned off.
- 2 Make connections to the device you want to connect to using a DV cable, as shown in the illustration.
- 3 If necessary, connect the PC connection cable (provided with GV-DT3) to the printer's PC connector and the PC's RS-232C connector.
- 4 Turn the camcorder's Power Switch to "PLAY" while pressing down the Lock Button located on the switch and turn on the other units.

NOTES:

- *It is recommended to use the AC Power Adapter/Charger as the power supply instead of the battery pack (☞ pg. 7).*
- *For Digital Dubbing, this camcorder can be connected only to one device at a time. This camcorder can also be used as a recorder.*
- *If Still Playback, Slow-Motion Playback, Fast-Forward or Rewind is attempted with the camcorder connected to a video unit via the DV connector, the image will take on an effect similar to a coloured mosaic pattern or it will become black.*
- *Also refer to the instruction manuals of the connected units.*
- *When using a DV cable, be sure to use the optional JVC VC-VDV204U DV cable.*

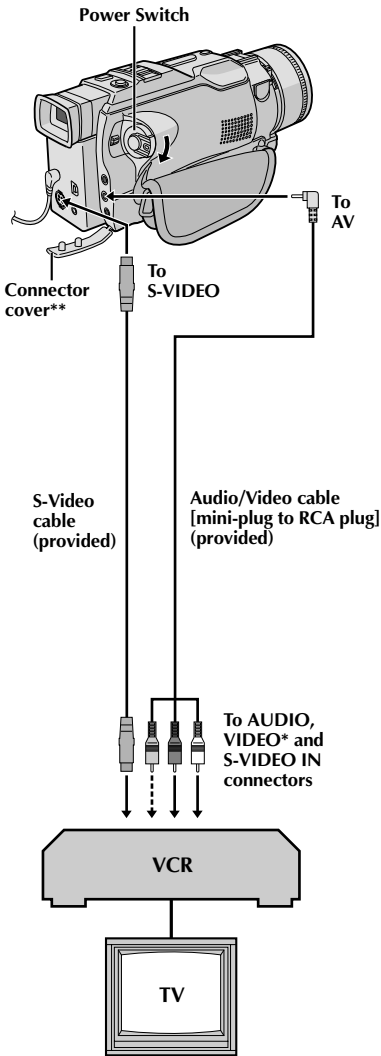

* Connect when an S-Video cable is not used.

** When connecting the cables, open this cover.

Dubbing To A VCR

[To use this camcorder as a player]

- 1** Following the illustration, connect the camcorder and the VCR. Also refer to pg. 52 and 53.
- 2** Set the camcorder's Power Switch to "PLAY" while pressing down the Lock Button located on the switch, turn on the VCR's power, and insert the appropriate cassettes in the camcorder and the VCR.
- 3** Set "S/AV INPUT" to "OFF" in the Menu Screen (☞ pg. 39).
- 4** Engage the VCR's AUX and Record-Pause modes.
- 5** Engage the camcorder's Play mode to find a spot just before the edit-in point. Once it is reached, press ►/II on the camcorder.
- 6** Press ►/II on the camcorder and engage the VCR's Record mode.
- 7** Engage the VCR's Record-Pause mode and press ►/II on the camcorder.
- 8** Repeat steps 5 through 7 for additional editing, then stop the VCR and camcorder when finished.

NOTES:

- You can use Playback Zoom (☞ pg. 63) or Playback Special Effects (☞ pg. 64) in step 6.
- Before you start dubbing, make sure that the indications do not appear on the connected TV. If they do, they are being recorded onto the new tape.

To choose whether or not the following displays appear on the connected TV . . .

- Date/Time
.... set "DATE/TIME" to "AUTO", "ON" or "OFF" in the Menu Screen (☞ pg. 39).
- Time Code
.... set "TIME CODE" to "ON" or "OFF" in the Menu Screen (☞ pg. 39).
- Playback Sound Mode, Tape Speed And Tape Running Displays
.... set "ON SCREEN" to "LCD" or "LCD/TV" in the Menu Screen (☞ pg. 39). Or, press **DISPLAY** on the remote control.

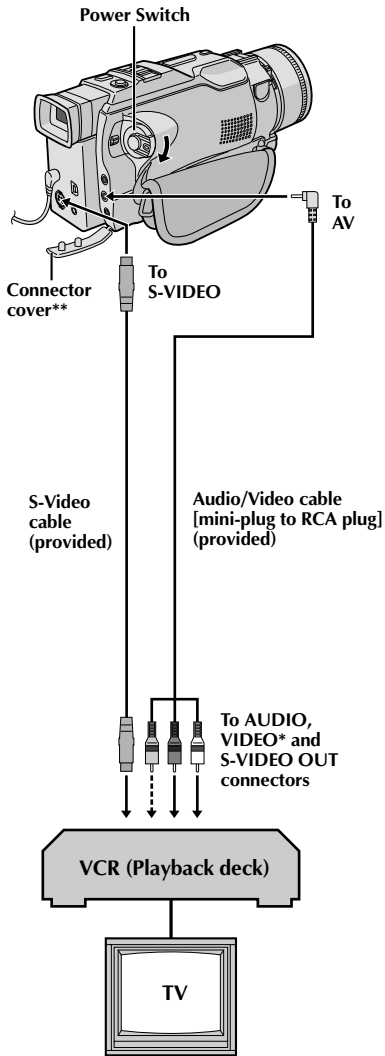

- * Connect when an S-Video cable is not used.
 ** When connecting the cables, open this cover.

Dubbing From A VCR

[To use this camcorder as a recorder]

- 1** Make sure all units are turned off, then connect the camcorder and the VCR as shown in the illustration. Also refer to pg. 52 and 53.
- 2** Set "SOUND MODE" to "12 BIT" or "16 BIT" and "REC MODE" to "SP" or "LP" in the Menu Screen depending on your preference (☞ pg. 39).
- 3** Set the camcorder's Power Switch to "**PLAY**" while pressing down the Lock Button located on the switch. Turn on the VCR's power and insert the appropriate cassettes in the camcorder and the VCR.
- 4** Set "S/AV INPUT" to "ON" in the Menu Screen to engage the analogue input mode (☞ pg. 39).
- 5** Press the Recording Start/Stop Button on the camcorder to engage the Record-Pause mode. "**AV.IN**" appears on the screen.
- 6** Engage the VCR's Play mode, then engage the Still Playback mode when you have found a spot just before the edit-in point.
- 7** Press the Recording Start/Stop Button on the camcorder to engage the Record mode. ⏪ rotates on the screen. Engage the VCR's Play mode.
- 8** To stop dubbing, press the Recording Star/Stop Button on the camcorder so that ⏪ stops rotating, then engage the VCR's Stop mode.
- 9** Repeat steps **6** through **8** for additional editing.
- 10** Set "S/AV INPUT" back to "OFF" in the Menu Screen to disengage the analogue input mode (☞ pg. 39).

NOTES:

- *It is recommended to use the AC Power Adapter/Charger as the power supply instead of the battery pack (☞ pg. 7).*
- *Analogue signals can be converted to digital signals with this procedure.*
- *It is also possible to dub from another camcorder.*

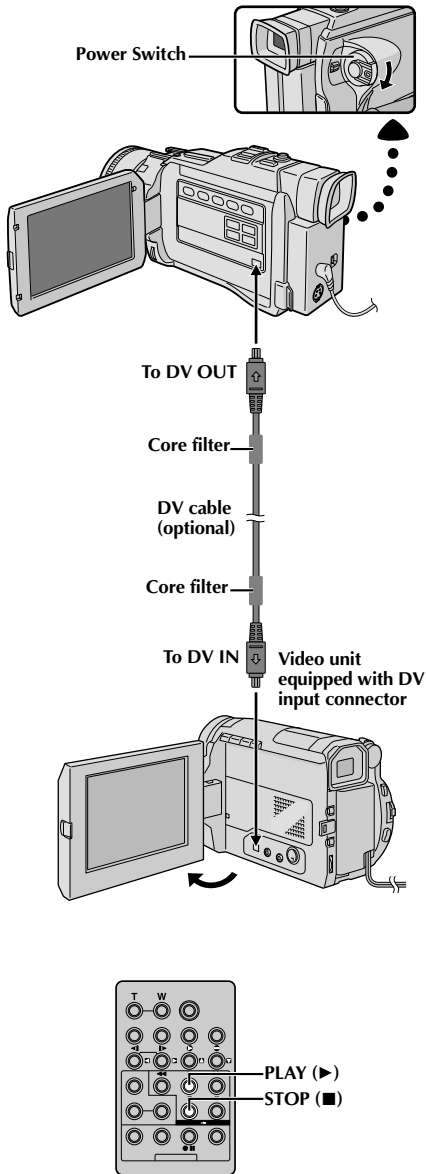

Dubbing To A Video Unit Equipped With A DV Connector (Digital Dubbing)

It is also possible to copy recorded scenes from the camcorder onto another video unit equipped with a DV connector. Since a digital signal is sent, there is little if any image or sound deterioration.

[To use this camcorder as a player]

- 1** Make sure all units are turned off. Connect the camcorder to a video unit equipped with a DV input connector using a DV cable as shown in the illustration.
- 2** Set the camcorder's Power Switch to "PLAY" while pressing down the Lock Button located on the switch, turn on the video unit's power, and insert the appropriate cassettes in the camcorder and the video unit.
- 3** Press ▶ to play back the source tape.
- 4** While watching the playback on the monitor, engage the DV connector-equipped video unit's record mode from the spot on the source tape you want to begin recording.

NOTES:

- *It is recommended to use the AC Power Adapter/Charger as the power supply instead of the battery pack (☞ pg. 7).*
- *If the remote control is used when both the player and recorder are JVC video units, both units will perform the same operation. To prevent this from happening, press the buttons on both units.*
- *For Digital Dubbing, this camcorder can be connected only to one device at a time.*
- *If a blank portion or disturbed image is played back on the player during dubbing, the dubbing may stop so that an unusual image is not dubbed.*
- *Even though the DV cable is connected correctly, sometimes the image may not appear in step 4. If this occurs, turn off the power and make connections again.*
- *If "Playback Zoom" (☞ pg. 63), "Playback Special Effects" (☞ pg. 64) or "Snapshot" is attempted during playback, only the original playback image recorded on the tape is output from the DV OUT connector.*
- **When using a DV cable, be sure to use the optional JVC VC-VDV204U DV cable.**

Dubbing From A Video Unit Equipped With A DV Connector (Digital Dubbing)

[To use this camcorder as a recorder]

NOTE:

Before the following steps, make sure that "S/AV INPUT" is set to "OFF" in the Menu Screen (☞ pg. 39).

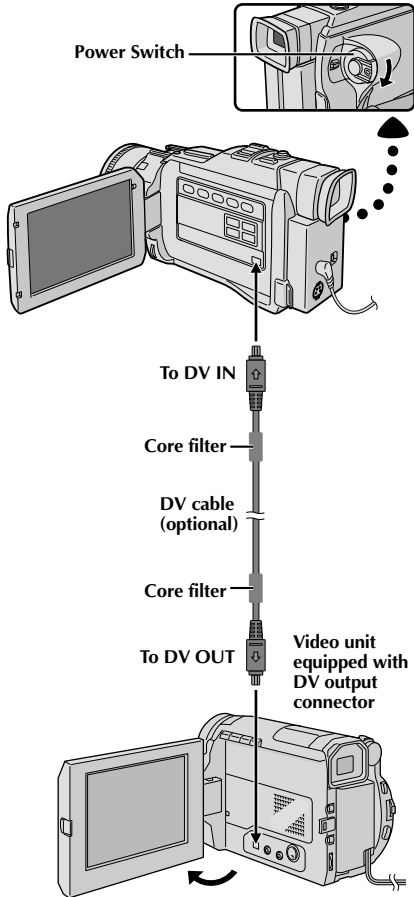

- 1** Make sure all units are turned off. Connect the camcorder to a video unit equipped with a DV output connector using a DV cable as shown in the illustration.
- 2** Set "REC MODE" to "SP" or "LP" in the Menu Screen depending on your preference (☞ pg. 39).
- 3** Set this camcorder's Power Switch to "PLAY" while pressing down the Lock Button located on the switch. Turn on the video unit's power and insert the appropriate cassettes in the camcorder and the video unit.
- 4** Press the Recording Start/Stop Button on the camcorder to engage the Record-Pause mode. "DV.IN" appears on the screen.
- 5** Engage the video unit's Play mode, then engage the Still Playback mode when you have found a spot just before the edit-in point.
- 6** Press the Recording Start/Stop Button on the camcorder to engage the Record mode. ⏪ rotates on the screen. Engage the video unit's Play mode.
- 7** To stop dubbing, press the Recording Start/Stop Button on the camcorder so that ⏪ stops rotating, then engage the video unit's Stop mode.
- 8** Repeat steps 5 through 7 for additional editing.

NOTES:

- It is recommended to use the AC Power Adapter/Charger as the power supply instead of the battery pack (☞ pg. 7).
- If the remote control is used when both the player and recorder are JVC video units, both units will perform the same operation. To prevent this from happening, press the buttons on both units.
- For Digital Dubbing, this camcorder can be connected only to one device at a time.
- If a blank portion or disturbed image is played back on the player during dubbing, the dubbing may stop so that an unusual image is not dubbed.
- Even though the DV cable is connected correctly, sometimes the image may not appear in step 5. If this occurs, turn off the power and make connections again.
- When using a DV cable, be sure it has a core filter attached. The core filter reduces interference.
- Digital Dubbing is performed in the sound mode recorded on the original tape, regardless of the current "SOUND MODE" setting (☞ pg. 27).
- During Digital Dubbing, no signals are output from the video or audio connectors.

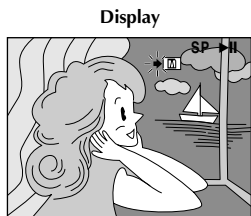
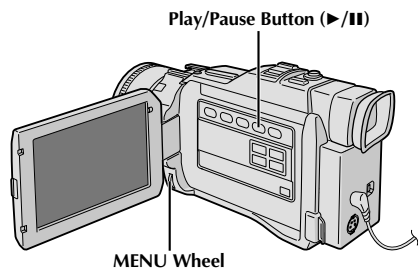
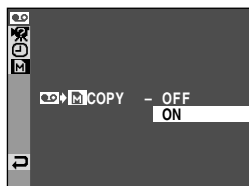
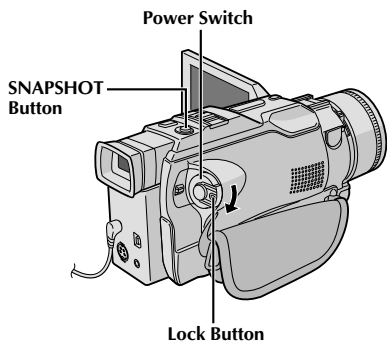

Dubbing Images Recorded On A Tape To A Memory Card

Images can be dubbed from a tape to a memory card .

- 1** Load a memory card (☞ pg. 11) and cassette (☞ pg. 10).
- 2** Set the Power Switch to “PLAY” while pressing down the Lock Button. Open the LCD monitor fully or pull out the viewfinder fully.
- 3** Press the MENU wheel. The Menu Screen appears. Rotate it to select “VIDEO” and press it. The VIDEO Menu appears.
- 4** Rotate the MENU wheel to select “▶ M COPY” and press it. The Sub Menu appears. Rotate it to select “ON” and press it. Selection is complete.
- 5** Rotate the MENU wheel to select “◀ RETURN” and press it twice. The normal playback screen resumes.
- 6** To select a video image to be dubbed, start playback by pressing ▶/II. At the moment you find the image you wish to dub, press it again to engage Still Playback.
- 7** To start dubbing, press SNAPSHOT. The selected image is stored in the memory card.
•“▶” blinks during dubbing.

NOTES:

- If SNAPSHOT is pressed in step 7 when a memory card is not loaded, the message “COPYING FAILED” is displayed.
- If an image recorded on the tape using the WIDE mode (☞ pg. 28) is dubbed to a memory card, the WIDE mode identifying signal is not dubbed with it.
- To use Playback Special Effects with a video image you wish to dub, perform up to step 7 using the remote control (provided) (☞ pg. 64).
- Images are dubbed in VGA file size.

The Full-Function Remote Control Unit can operate this camcorder from a distance as well as the basic operations (Playback, Stop, Pause, Fast-Forward and Rewind) of your VCR. It also makes additional playback functions possible.

Installing The Batteries

The remote control uses two "AAA (R03)" size batteries. See "General Battery Precautions" (☞ pg. 89).

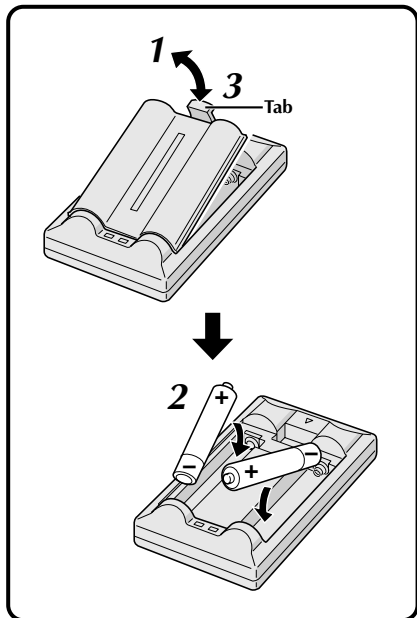

- 1** Remove the battery compartment cover while pushing up the tab as illustrated.
- 2** Insert two "AAA (R03)" size batteries in the correct direction.
- 3** Re-attach the battery compartment cover.

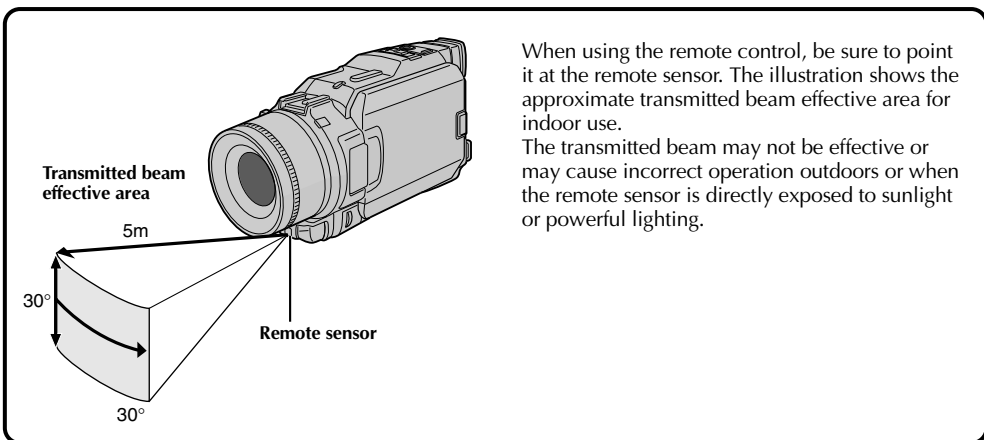

When using the remote control, be sure to point it at the remote sensor. The illustration shows the approximate transmitted beam effective area for indoor use.

The transmitted beam may not be effective or may cause incorrect operation outdoors or when the remote sensor is directly exposed to sunlight or powerful lighting.

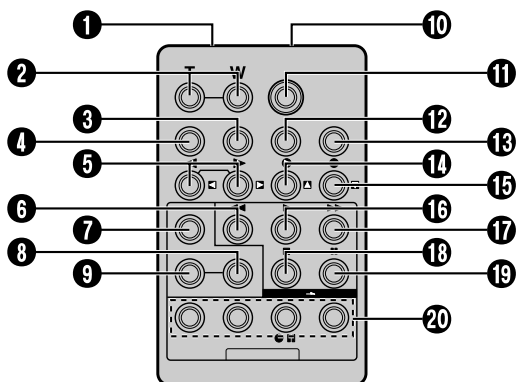

Buttons	Functions	
	With the camcorder's Power Switch set to the camera position ("A" or "M").	With the camcorder's Power Switch set to "PLAY".
❶ Infrared beam transmitting window	Transmits the beam signal.	
❷ Zoom (T/W) Buttons	Zoom in/out (☞ pg. 20)	Zoom in/out (☞ pg. 63)
❸ DISPLAY Button	—	☞ pg. 66
❹ SHIFT Button	—	☞ pg. 63, 65
❺ SLOW Rewind/Forward Buttons Left/Right Buttons	— —	☞ pg. 63 ☞ pg. 63
❻ REW Button	—	<ul style="list-style-type: none"> • Rewind/Reverse Shuttle Search on the tape (☞ pg. 38) • Displays previous image in the memory card (☞ pg. 42)
❼ FADE/WIPE Button	—	☞ pg. 67
❽ EFFECT ON/OFF Button	—	☞ pg. 64
❾ EFFECT Button	—	☞ pg. 64
❿ PAUSE IN Connector	—	☞ pg. 66
⓫ START/STOP Button	Functions the same as the Recording Start/Stop Button on the camcorder.	
⓬ MBR SET Button	—	☞ pg. 65
⓭ SNAPSHOT Button	Functions the same as SNAPSHOT on the camcorder.	
⓮ Up Button INSERT Button	— —	☞ pg. 63 ☞ pg. 72
⓯ Down Button A. DUB Button	— —	☞ pg. 63 ☞ pg. 71
⓰ PLAY Button	—	<ul style="list-style-type: none"> • Starts Playback of the tape (☞ pg. 38) • Starts Auto Playback of the memory card (☞ pg. 42)
⓱ FF Button	—	<ul style="list-style-type: none"> • Forward/Forward Shuttle Search on the tape (☞ pg. 38) • Displays next image in the memory card (☞ pg. 42)
⓲ STOP Button	—	<ul style="list-style-type: none"> • Stops the tape (☞ pg. 38) • Stops Auto Playback (☞ pg. 42)
⓳ PAUSE Button	—	Pauses the tape (☞ pg. 63)
⓴ R.A.EDIT Buttons	—	☞ pg. 65 – 70

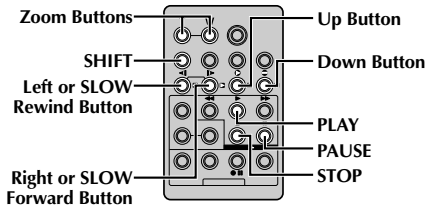
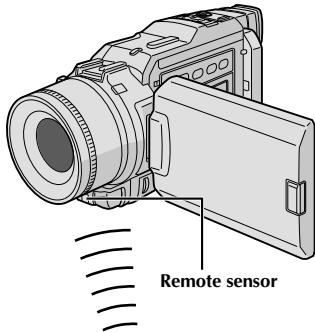

Normal playback

Press T



To move image, press **▶** (Right) while keeping **SHIFT** held down.

FEATURE: Slow-Motion Playback

PURPOSE:

To allow slow-speed search in either direction during video playback.

OPERATION:

1) To change from normal to Slow-Motion Playback, press **SLOW** (**◀** or **▶**) more than approx. 2 seconds. After approx. 5 minutes (approx. 20 seconds with a 80-minute cassette) in Slow Rewind or Forward, normal playback resumes.

■ To stop Slow-Motion Playback, press **PLAY** (**▶**).

NOTES:

- You can also engage Slow-Motion Playback from Still Playback by pressing **SLOW** more than approx. 2 seconds.
- During Slow-Motion Playback, due to digital image processing, the picture may take on a mosaic effect.
- After **SLOW** (**◀** or **▶**) is pressed and held, the still image may be displayed for a few seconds, followed by a blue screen for a few seconds. This is not a malfunction.
- There may be a small margin between the slow-motion playback start point you chose and the actual start point for Slow-Motion Playback.
- During Slow-Motion Playback, there will be disturbances in video and the picture may seem unstable, especially with steady images. This is not a malfunction.
- During Slow-Motion Playback, press **PAUSE** (**⏸**) to pause playback.

FEATURE: Frame-By-Frame Playback

PURPOSE:

To allow frame-by-frame search during video playback.

OPERATION:

1) To change from normal to Frame-By-Frame Playback, press **SLOW** (**▶**) repeatedly for forward or **SLOW** (**◀**) repeatedly for reverse. Each time it is pressed, the frame is played back.

NOTE:

You can also engage Frame-By-Frame Playback from Still Playback by pressing **SLOW** (**◀** or **▶**) repeatedly.

FEATURE: Playback Zoom

PURPOSE:

To magnify the recorded image up to 10X at any time during playback.

OPERATION:

- 1) Press **PLAY** (**▶**) to find the scene of interest.
 - 2) Press the Zoom Buttons (**T/W**) on the remote control. Make sure the remote control is pointed at the camcorder's remote sensor. Pressing **T** zooms in.
 - 3) You can move the image on screen around to find a particular portion of the picture. While holding down **SHIFT**, press **◀** (Left), **▶** (Right), **▲** (Up) and **▼** (Down).
- To end zoom, press and hold **W** until magnification returns to normal. Or, press **STOP** (**■**) and then press **PLAY** (**▶**).

NOTES:

- Zoom can also be used during slow-motion and still playback.
- Due to digital image processing, the quality of the image may suffer.
- Playback Zoom cannot be used on images that were recorded when "CAMERA MODE" is set to "PS-VIDEO" (☞ pg. 26, 27).

PLAYBACK EFFECT

- | | |
|-----|--------------|
| OFF | |
| 1 | CLASSIC FILM |
| 2 | MONOTONE |
| 3 | SEPIA |
| 4 | STROBE |
| 5 | VIDEO ECHO |

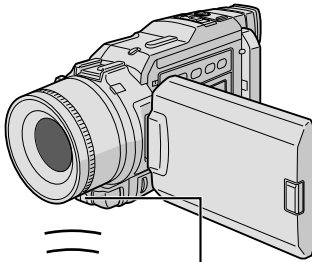
PLAYBACK EFFECT
Select Menu

Remote sensor

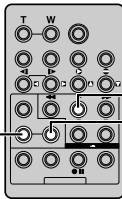

EFFECT

PLAY

EFFECT ON/OFF

FEATURE: Playback Special Effects**PURPOSE:**

To allow you to add creative effects to the video playback image.

OPERATION:

- 1) To start playback, press **PLAY** (▶).
- 2) Point the remote control at the camcorder's remote sensor and press **EFFECT**. The **PLAYBACK EFFECT Select Menu** appears.
- 3) Move the highlight bar to the desired effect by pressing **EFFECT**. The selected function is activated and after 2 seconds the menu disappears.
 - To deactivate the selected effect, press **EFFECT ON/OFF** on the remote control. Pressing it again re-activates the selected effect.
 - To change the selected effect, repeat from step 2 above.

NOTES:

- When some *Playback Special Effects* are used, the *Multi-Analyser 4* and *Multi-Analyser 9 Snapshot modes* (▶ pg. 18) are not available.
- The effects that can be used during playback are *Classic Film*, *Monotone*, *Sepia*, *Strobe* and *Video Echo*. The effects work the same in playback as they did in recording. Refer to page 35 for more information.

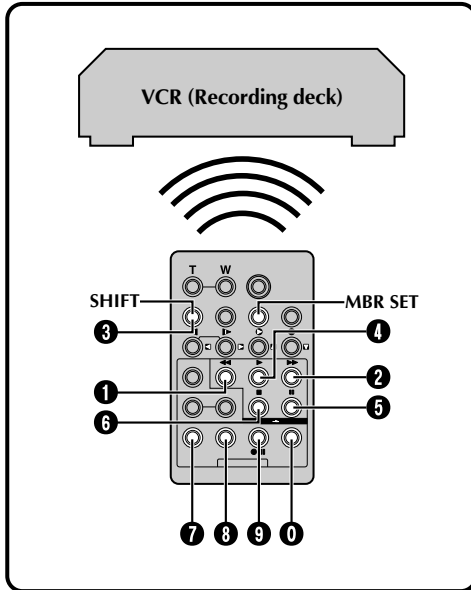

VCR CODE LIST

VCR BRAND NAME	BUTTONS (A) (B)	VCR BRAND NAME	BUTTONS (A) (B)
AKAI	6 2 6 4 7 7	PHILIPS	1 9 9 5 1 1 9 4 9 1
BLAUPUNKT	1 3		9 6 1 2 3 3 7 2
FERGUSON	9 7 9 8 3 2	SANYO	3 6 3 5
GRUNDIG	1 4 3 4	SELECO, REX	9 1 9 6
HITACHI	6 6 6 3	SHARP	1 5 1 0
JVC A B C	9 1 9 6 9 3	SONY	6 5 6 0 3 9 3 1
MITSUBISHI	6 7 6 8	THOMSON, TELEFUNKEN, SABA, NORDMENDE	9 1 9 6 9 7 3 2
NEC	3 7 3 8	TOSHIBA	6 9 6 1
PANASONIC	1 3 1 7 1 1 9 4 1 8		

Random Assemble Editing [R.A.Edit]

Create edited videos easily using your camcorder as the source player. You can select up to 8 "cuts" for automatic editing, in any order you like. R.A.Edit is more easily performed when the MBR (Multi-Brand Remote) is set to operate with your brand of VCR (see VCR CODE LIST), but can also be performed by operating the VCR manually.

Before operation, make sure the batteries are installed in the remote control (☞ pg. 61).

SET REMOTE/VCR CODE

1 Turn off the power to the VCR and point the remote towards the VCR's infrared sensor. Then, referring to the VCR CODE LIST, press and hold **MBR SET**, and press button (A) and then (B). The code is automatically set once you release **MBR SET**, and the VCR's power comes on.

2 Make sure the VCR's power is on. Then, while holding **SHIFT**, press the button on the remote for the desired function. The functions the remote can control are PLAY, STOP, PAUSE, FF, REW and VCR REC STBY (you do not need to press **SHIFT** for this one).

You are now ready to try Random Assemble Editing.

IMPORTANT

Although the MBR is compatible with JVC VCRs and those of many other makers, it may not work with yours or may offer limited functions.

NOTES:

- If the VCR's power does not come on in step 1, try another code from the VCR CODE LIST.
- Some brands of VCR do not come on automatically. In this case, turn the power on manually and try step 2.
- If the remote control is not able to control the VCR, use the controls on the VCR.
- When the remote control's batteries run out, the VCR brand you have set will be erased. In that case, replace the old battery with a new one to reset the VCR brand.

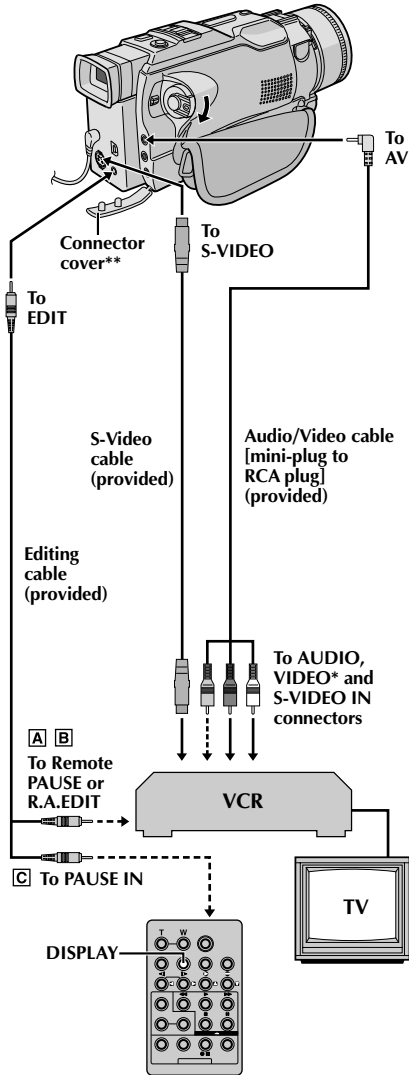

* Connect when an S-Video cable is not used.

** When connecting cables, open this cover.

MAKE CONNECTIONS

Also refer to pg. 52 and 53.

1

A A JVC VCR equipped with a remote pause connector . . .

... connect the editing cable to the Remote PAUSE connector.

B A JVC VCR not equipped with a remote pause connector but equipped with an R.A.EDIT connector . . .

... connect the editing cable to the R.A.EDIT connector.

C A VCR other than above . . .

... connect the editing cable to the remote control's PAUSE IN connector.

2

Insert a recorded tape into the camcorder and set the Power Switch to "PLAY" while pressing down the Lock Button located on the switch.

3

Turn the VCR power on, insert a recordable tape and engage the AUX mode (refer to the VCR's instructions).

NOTES:

- Before Random Assemble Editing, make sure the indications do not appear on the TV monitor. If they do, they will be recorded onto the new tape.

To choose whether or not the following displays appear on the connected TV . . .

- Date/Time
 - set "DATE/TIME" to "AUTO", "ON" or "OFF" in the Menu Screen (☞ pg. 39).
- Time Code
 - set "TIME CODE" to "ON" or "OFF" in the Menu Screen (☞ pg. 39).
- Playback Sound Mode, Tape Speed And Tape Running Displays
 - set "ON SCREEN" to "LCD" or "LCD/TV" in the Menu Screen (☞ pg. 39). Or, press **DISPLAY** on the remote control.
- Make sure to set "S/AV INPUT" to "OFF" in the Menu Screen (☞ pg. 39).
- When editing on a VCR equipped with a DV input connector, an optional DV cable can be connected instead of an S-Video cable and audio/video cable.

Programme

	IN	OUT	MODE
1	----	----	----
2	----	----	----
3	----	----	----
4	----	----	----
5	----	----	----
6	----	----	----
7	----	----	----
8	----	----	----

TIME CODE --:--
TOTAL 00:00

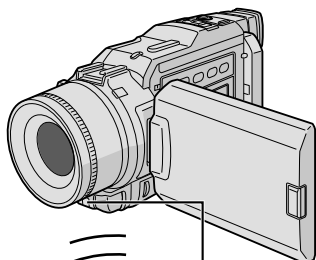
Random Assemble
Editing Menu

Remote sensor

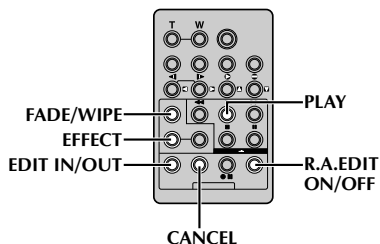

SELECT SCENES

- 4** Point the remote control at the camcorder's remote sensor. Press **PLAY** (▶) and then press **R.A.EDIT ON/OFF** on the remote control. The Random Assemble Editing Menu appears.
- 5** If using a Fade/Wipe at the beginning of the scene, press **FADE/WIPE** on the remote control.
 - Cycle through the effects by pressing repeatedly, and stop when the one you want is displayed.
 - You cannot use a Picture Wipe/Dissolve at the beginning of Programme 1.
- 6** At the beginning of the scene, press **EDIT IN/OUT** on the remote control. The Edit-In position appears in the Random Assemble Editing Menu.
- 7** At the end of the scene, press **EDIT IN/OUT**. The Edit-Out position appears in the Random Assemble Editing Menu.
- 8** If using a Fade/Wipe at the end of the scene, press **FADE/WIPE**.
 - Cycle through the effects by pressing repeatedly, and stop when the one you want is displayed.
 - If you select a Fade/Wipe effect for an Edit-Out point, the effect is automatically applied to the following Edit-In point.
 - You cannot use a Picture Wipe/Dissolve at the end of the last scene.
 - When you use Fade/Wipe effects, that time is included in the total time (this does not apply to Picture Wipe/Dissolve).
- 9** If using Playback Special Effects, press **EFFECT** (Ⓛ pg. 64).
- 10** Repeat steps **6** through **9** to register additional scenes.
 - To change previously registered points, press **CANCEL** on the remote control. The registered points disappear, one at a time, from the most recently registered point.
 - If you are not using Fade/Wipe or Programme AE with special effects, repeat steps **6** and **7** only.

CONTINUED ON NEXT PAGE

NOTES:

- When choosing a scene, set Edit-In and Edit-Out points so that there is a relatively large difference between them.
- If the search time for an in-point exceeds 5 minutes, the recording deck's Record-Standby mode will be cancelled and editing will not take place.
- If there are blank portions before or after the Edit-In and Edit-Out points, a blue screen may be included in the edited version.
- Since time codes register time only as accurately as seconds, the time code total time may not match the total programme time exactly.
- Turning off the camcorder's power erases all registered Edit-In and Edit-Out points.
- If you select Sepia or Monotone mode from Programme AE with special effects, you cannot use the Dissolve or Black & White Fader. In this case the Dissolve or Black & White indicator begins blinking. Once the next Edit-In point is registered, the effect is turned off. To combine these effects, use Sepia or Monotone during recording, then use the Dissolve or Black & White Fader during Random Assemble Editing.
- It is not possible to use Fade/Wipe effects and Programme AE with special effects during Random Assemble Editing using a DV cable.

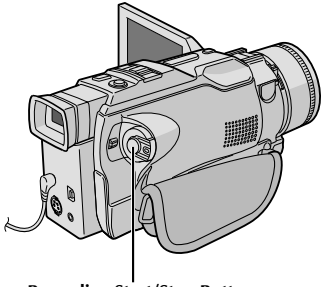

Recording Start/Stop Button

	IN	OUT	MODE
1	00:25	02:05	IP
2	07:18	08:31	
3	03:33	05:53	BW
4	09:30	13:15	
5	15:55	16:29	
6			
7			
8			
TIME CODE		16:30	
TOTAL		9:39	

Random Assemble Editing Menu

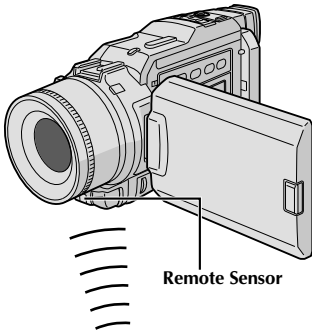

Remote Sensor

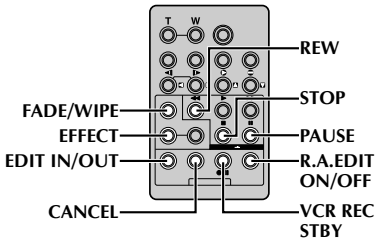

AUTOMATIC EDITING TO VCR

11 Rewind the tape in the camcorder to the beginning of the scene you want to edit and press **PAUSE (II)**.

12 Point the remote control towards the VCR's remote sensor and press **VCR REC STBY (●II)**, or manually engage the VCR's Record-Pause mode.

13 Press the Recording Start/Stop Button on the camcorder. Editing proceeds as programmed, right through to the end of the last registered scene.

- Pressing **START/STOP** on the remote control does not start editing.
- When dubbing is complete, the camcorder enters the Pause mode, and the VCR enters its Record-Pause mode.
- If you do not register an Edit-Out point, the tape will be dubbed all the way to the end automatically.
- If you operate the camcorder during automatic editing, the VCR will enter its Record-Pause mode and automatic editing will stop.

14 Engage the Stop modes for the camcorder and the VCR.
To make the R.A.Edit counter display disappear, press **R.A.EDIT ON/OFF** on the remote control.

NOTES:

- Pressing **R.A.EDIT ON/OFF** on the remote control clears all settings registered during Random Assemble Editing.
- When the editing cable is connected to the remote control's Pause In connector during dubbing, make sure the remote control is pointed at the VCR's sensor, and the path between the two is unobstructed.
- Random Assemble Editing may not function properly when using a tape including several duplicated time codes (see pg. 21).

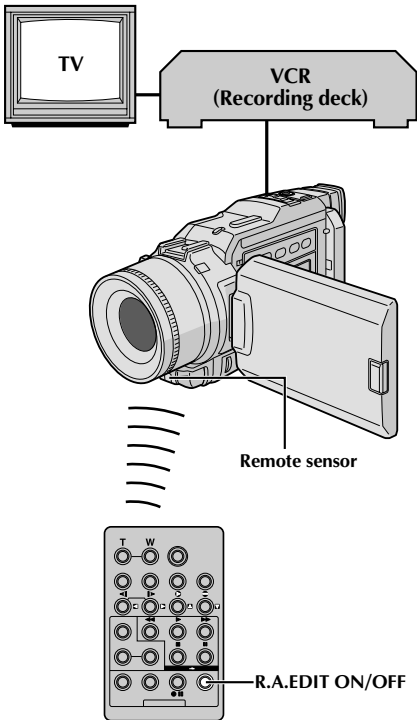
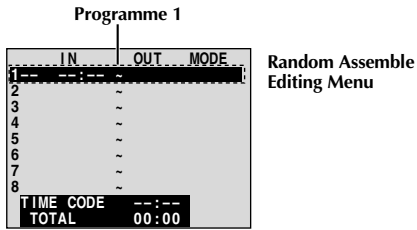

For More Accurate Editing

Some VCRs make the transition from Record-Pause to Record mode faster than others. Even if you begin editing for the camcorder and the VCR at exactly the same time, you may lose scenes you wanted, or find that you have recorded scenes you did not want. For a cleanly edited tape, confirm and adjust the timing of the camcorder against your VCR.

DIAGNOSING VCR/CAMCORDER TIMING

- 1 Play back the tape in the camcorder, then point the remote control at the camcorder's remote sensor and press **R.A.EDIT ON/OFF**. The Random Assemble Editing Menu appears.
- 2 Perform Random Assemble Editing on Programme 1 only. In order to check VCR and camcorder timing, select the beginning of a scene transition as your Edit-In point.
- 3 Play back the dubbed scene.
 - If any images from the scene prior to the transition you chose for your Edit-In point were recorded, that means your VCR moves too quickly from Record-Pause to Record mode.
 - If the scene you tried to dub starts in progress, the VCR is slow to start recording.

CONTINUED ON NEXT PAGE

Display

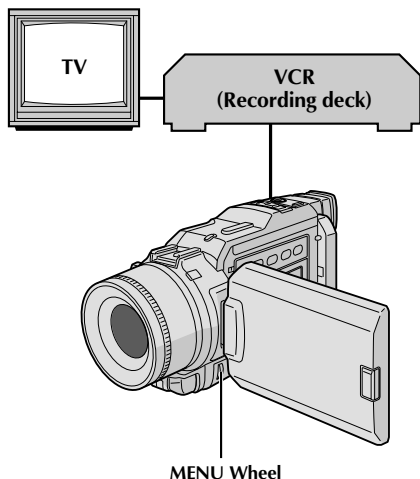
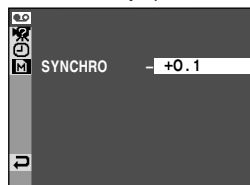

ADJUSTMENT OF VCR/CAMCORDER TIMING

- 4 Point the remote control at the camcorder's remote sensor and press **R.A.EDIT ON/OFF** to make the Random Assemble Editing menu disappear, then press the **MENU** wheel. The Menu Screen appears.
- 5 Rotate the **MENU** wheel to select "**0.6** VIDEO" and press it. The VIDEO Menu appears. Then, rotate it to "SYNCHRO" and press it. The value for "SYNCHRO" is highlighted.
- 6 Based on the diagnostics performed (☞ pg. 69), you can now advance the VCR's record timing by rotating the **MENU** wheel towards "▲". You can also delay the VCR's record timing by rotating the **MENU** wheel towards "▼". The adjustment range is from -1.3 to +1.3 seconds, in 0.1-second increments. Press the **MENU** wheel to finish the setting.
- 7 Rotate the **MENU** wheel to select "◀RETURN" and press it twice.
Now perform Random Assemble Editing beginning with step 4 on page 67.

NOTES:

- Before performing actual Random Assemble Editing, do a few Random Assemble Editing trial runs to check whether the value you have input is appropriate or not, and make adjustments accordingly.
- Depending on the recorder, there may be situations where the timing difference cannot be fully corrected.

Display

Audio Dub
Standby mode

Power Switch

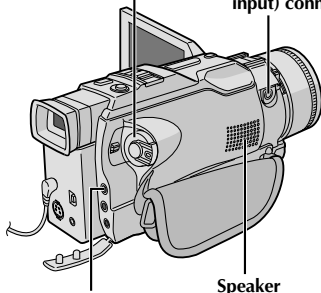
MIC (external
microphone
input) connector*PHONE
(headphone)
connector*

Speaker

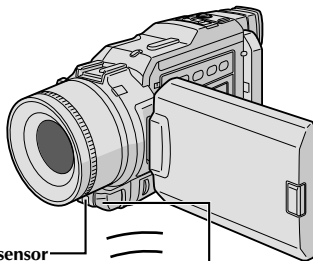

Remote sensor

Stereo
microphone

DISPLAY

PLAY

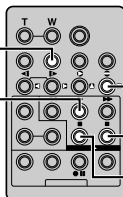

A.DUB

PAUSE

STOP

Audio Dubbing

The audio track can be customized only when recorded in the 12-bit mode (☞ pg. 27).

NOTES:

- Audio Dubbing is not possible on a tape recorded in 16-bit audio, on a tape recorded in the LP mode or on a blank portion of a tape.
- To perform Audio Dubbing while watching on the television, make connections (☞ pg. 52).

1 Play back the tape to locate the point where editing will start, then press **PAUSE (II)**.

2 While holding **A.DUB (II)** on the remote control, press **PAUSE (II)**. "II" appears.

3 Press **PLAY (▶)**, then begin "narrating".
Speak into the microphone.
• To pause dubbing, press **PAUSE (II)**.

4 To end Audio Dubbing, press **PAUSE (II)**, then **STOP (■)**.

To hear the dubbed sound during playback . . .

.... set "12BIT MODE" to "SOUND 2" or "MIX" in the Menu Screen (☞ pg. 39, 40).

NOTES:

- Audio dubbing is also possible using an optional microphone connected to the MIC connector.
- Sound is not heard from the speaker during Audio Dubbing. To hear sound, connect optional headphones to the PHONE connector.
- While an optional microphone is connected, the built-in microphone is disabled.
- When editing onto a tape that was recorded at 12-bit, the old and new soundtracks are recorded separately.
- If you dub onto a blank space on the tape, the sound may be disrupted. Make sure you only edit recorded areas.
- If feedback or howling occurs during TV playback, move the camcorder's microphone away from the TV, or turn down the TV's volume.
- If you change from 12-bit to 16-bit in mid-recording and then use the tape for Audio Dubbing, it is not effective from the point where 16-bit recording began.
- During Audio Dubbing, when the tape moves to scenes recorded in the LP mode, scenes recorded in 16-bit audio or a blank portion, Audio Dubbing stops (☞ pg. 87).
- To perform Audio Dubbing with a video unit connected to the camcorder's AV connector, first set "S/AV INPUT" to "ON" in the Menu Screen (☞ pg. 39). You can hear sound from the video unit using optional headphones.

* Located beneath the cover.

Display



Power Switch

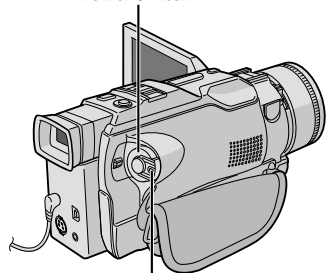

Lock Button

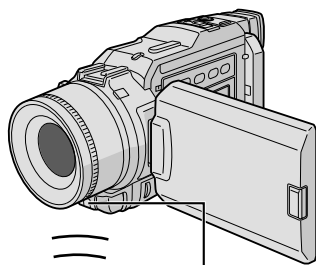

Remote sensor

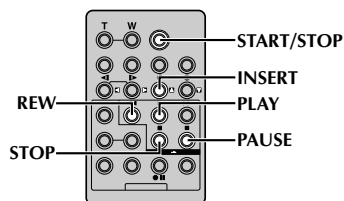

Insert Editing

You can record a new scene into a previously recorded tape, replacing a section of the original recording with minimal picture distortion at the in and outpoints. The original audio remains unchanged.

NOTES:

- Before performing the following steps, make sure that "TIME CODE" is set to "ON" in the Menu Screen (☞ pg. 39).
- Insert Editing is not possible on a tape recorded in the LP mode or on a blank portion of a tape.
- To perform Insert Editing while watching in the television, make connections (☞ pg. 52).

- 1 Play back the tape, locate the Edit-Out point and press **PAUSE (II)**. Confirm the time code at this point (☞ pg. 40).
- 2 Press **REW (◀◀)** until the Edit-In point is located, then press **PAUSE (II)**.
- 3 Press and hold **INSERT (Ⓞ)** on the remote control, then press **PAUSE (II)**. "IIⓄ" and the Time Code (min.:sec.) appear and the camcorder enters Insert-Pause mode.
- 4 Press **START/STOP** to begin editing.
 - Confirm the insert at the time code you checked in step 1.
 - To pause editing, press **START/STOP**. Press it again to resume editing.
- 5 To end Insert Editing, press **START/STOP**, then **STOP (■)** on the remote control. Do not press the Stop button (■) on the camcorder since this will activate backlight compensation instead.

NOTES:

- Programme AE with special effects (☞ pg. 34, 35) can be used to spice up the scenes being edited during Insert Editing.
- During Insert Editing, the date and time information changes.
- If you perform Insert Editing onto a blank space on the tape, the audio and video may be disrupted. Make sure you only edit recorded areas.
- During Insert Editing, when the tape moves to scenes recorded in the LP mode or a blank portion, Insert Editing stops (☞ pg. 87).

If, after following the steps in the chart below, the problem still exists, please consult your nearest JVC dealer.

The camcorder is a microcomputer-controlled device. External noise and interference (from a TV, a radio, etc.) might prevent it from functioning properly. In such cases, first disconnect its power supply unit (battery pack, AC Power Adapter/Battery Charger, etc.) and wait a few minutes; and then re-connect it and proceed as usual from the beginning.

SYMPTOM	POSSIBLE CAUSES	CORRECTIVE ACTION
<p>1. No power is supplied.</p>	<p>1.</p> <ul style="list-style-type: none"> • The power is not connected properly. • The battery is dead. • The LCD monitor is not open fully or the viewfinder is not pulled out when recording. 	<p>1.</p> <ul style="list-style-type: none"> • Connect the AC Power Adapter/Charger securely (☞ pg. 7). • Replace the dead battery with a fully charged one (☞ pg. 6, 7). • Open the LCD monitor fully or pull out the viewfinder.
<p>2. "SET DATE/TIME!" appears.</p>	<p>2.</p> <ul style="list-style-type: none"> • The built-in clock's rechargeable lithium battery is discharged. • The previously set date/time is erased. 	<p>2.</p> <ul style="list-style-type: none"> • Connect the camcorder to an AC outlet using the AC Power Adapter/Charger for over 24 hours to charge the clock's lithium battery (☞ pg. 9).
<p>3. Recording cannot be performed.</p>	<p>3.</p> <ul style="list-style-type: none"> • The tape's erase protection tab is set to "SAVE". • The Power Switch is set to "PLAY" or "OFF". • "TAPE END" appears. • The cassette holder cover is open. 	<p>3.</p> <ul style="list-style-type: none"> • Set the tape's erase protection tab to "REC" (☞ pg. 10). • Set the Power Switch to "A" or "M" (☞ pg. 12). • Replace with new cassette (☞ pg. 10). • Close the cassette holder cover.
<p>4. There is no picture.</p>	<p>4.</p> <ul style="list-style-type: none"> • The camcorder is not getting power, or some other malfunction exists. 	<p>4.</p> <ul style="list-style-type: none"> • Turn the camcorder's power off and on again (☞ pg. 16).
<p>5. Some functions are not available using the MENU wheel.</p>	<p>5.</p> <ul style="list-style-type: none"> • The Power Switch is set to "A". 	<p>5.</p> <ul style="list-style-type: none"> • Set the Power Switch to "M" (☞ pg. 12).
<p>6. The focus does not adjust automatically.</p>	<p>6.</p> <ul style="list-style-type: none"> • Focus is set to the Manual mode. • The recording was done in a dark place, or the contrast was low. • The lens is dirty or covered with condensation. 	<p>6.</p> <ul style="list-style-type: none"> • Set Focus to the Auto mode (☞ pg. 25). • Clean the lens and check the focus again (☞ pg. 80).

SYMPTOM	POSSIBLE CAUSES	CORRECTIVE ACTION
7. The cassette will not load properly.	7. • The cassette is in the wrong position. • The battery's charge is low.	7. • Set it in the right position (☞ pg. 10). • Install a fully charged battery (☞ pg. 6, 7).
8. The memory card will not load properly.	8. • The memory card is in the wrong position.	8. • Set it in the right position (☞ pg. 11).
9. In the 5-Second mode, recording ends before 5 seconds have elapsed.	9. • The 5-Second mode is set to "ANIM." in the Menu Screen.	9. • Select "5S" in the Menu Screen (☞ pg. 31).
10. Snapshot mode cannot be used.	10. • The Squeeze mode is selected.	10. • Disengage the Squeeze mode (☞ pg. 28).
11. The colour of Snapshot looks strange.	11. • The light source or the subject does not include white. Or there are various different light sources behind the subject. • The Sepia or Monotone mode is activated.	11. • Find a white subject and compose your shot so that it also appears in the frame (☞ pg. 18, 19). • Turn off Sepia and Monotone (☞ pg. 34, 35).
12. The image taken using Snapshot is too dark.	12. • Shooting was performed under backlit conditions.	12. • Press the BACKLIGHT Button (☞ pg. 36).
13. The image taken using Snapshot is too bright.	13. • The subject is too bright.	13. • Set "PROGRAM AE" to "SPOTLIGHT" in the Menu Screen (☞ pg. 34).
14. Digital Zoom does not work.	14. • 10X optical zoom is selected. • The Shooting Mode Switch is set to "XGA/VGA" or "UXGA". • "PROGRAM AE" is set to "VIDEO ECHO" in the Menu Screen. • "WIDE MODE" is set to "PS-WIDE" in the Menu Screen. • Multi-Analyser 4 or Multi-Analyser 9 was attempted during Digital Zoom. • Picture Wipe or Dissolve are being used in a scene transition.	14. • Set "ZOOM" to "40X" or "300X" in the Menu Screen (☞ pg. 27). • Set the Shooting Mode Switch to "VIDEO" (☞ pg. 12, 20). • Disengage the "VIDEO ECHO" mode (☞ pg. 20, 35). • Disengage the "PS-WIDE" mode (☞ pg. 28). • Disengage Multi-Analyser 4 or Multi-Analyser 9 (☞ pg. 18). • Wait until the Picture Wipe or Dissolve effects are completed (☞ pg. 20, 32).
15. Programme AE with special effects and Fade/Wipe Effects do not work.	15. • The Power Switch is set to "A".	15. • Set the Power Switch to "M" (☞ pg. 32, 34).
16. The Black & White Fader does not work.	16. • The Sepia or Monotone mode is activated.	16. • Turn off Sepia and Monotone (☞ pg. 32, 34).

SYMPTOM	POSSIBLE CAUSES	CORRECTIVE ACTION
<p>17. The Dissolve function does not work.</p>	<p>17.</p> <ul style="list-style-type: none"> • The Sepia, Monotone or Slow Shutter mode of Programme AE with special effects is activated. • “WIDE MODE” is set to “SQUEEZE” or “PS-WIDE” in the Menu Screen. • The previously selected mode of Programme AE with special effects was changed after the last selected scene for editing was registered. 	<p>17.</p> <ul style="list-style-type: none"> • Turn off Sepia, Monotone or Slow Shutter before adding Dissolve to a scene transition (☞ pg. 32, 34). • Set “WIDE MODE” to “CINEMA” or “OFF” mode (☞ pg. 28). • Make sure you have selected the mode of Programme AE with special effects you want before starting editing (☞ pg. 32, 34).
<p>18. The Picture Wipe and Dissolve functions do not work.</p>	<p>18.</p> <ul style="list-style-type: none"> • The last selected editing scene is ending. • At the end of the last selected scene for editing, the Power Switch was set to “OFF”. • The power is off. 	<p>18.</p> <ul style="list-style-type: none"> • Select Picture Wipe or Dissolve before beginning recording. The effects are then automatically activated (☞ pg. 32). • Do not turn off the camcorder’s power after setting Edit-In and Edit-Out points, as they will all be erased (☞ pg. 32). • The camcorder automatically shuts off after 5 minutes have elapsed in the Record-Standby mode. Make sure you continue operations within 5 minutes after engaging Record-Standby mode (☞ pg. 32).
<p>19. The picture wipe function does not work.</p>	<p>19.</p> <ul style="list-style-type: none"> • The Slow Shutter mode is activated. • “WIDE MODE” is not set to “OFF”. 	<p>19.</p> <ul style="list-style-type: none"> • Disengage the Slow Shutter mode or set “WIDE MODE” to “OFF” before preparing to use the Picture Wipe (☞ pg. 28, 32, 34).
<p>20. Scene transition does not go as expected.</p>	<p>20.</p> <ul style="list-style-type: none"> • When using “Picture Wipe/ Dissolve” (☞ pg. 32), there is a delay of a fraction of a second between the previous record stop-point and the Dissolve start-point. This is normal, but this slight delay becomes especially noticeable when shooting fast-moving subject or during rapid panning. 	<p>20.</p> <p>_____</p>

SYMPTOM	POSSIBLE CAUSES	CORRECTIVE ACTION
21. The Video Echo mode does not work.	21. • The Picture Wipe or Dissolve functions are in use. • "WIDE MODE" is set to "SQUEEZE" or "PS-WIDE" in the Menu Screen. • A Fade-In or Fade-Out is in progress.	21. • Set "WIDE MODE" to "CINEMA" or "OFF" mode (☞ pg. 28). • Do not try to use the Video Echo mode during a Fade-In or Fade-Out (☞ pg. 32, 34).
22. Even when Slow Shutter is not selected, the image looks like it is activated.	22. • When shooting in the dark, the unit becomes highly sensitive to light and the image takes on an effect similar to Slow Shutter.	22. • If you want the lighting to look more natural, set GAIN UP to "AGC" or "OFF" in the Menu Screen (☞ pg. 27).
23. There is no strobe when the Classic Film or Strobe mode is activated.	23. • The Picture Wipe or Dissolve function is in use.	23. • Do not try to use the Classic Film or Strobe mode during a scene transition (☞ pg. 32, 34).
24. White Balance cannot be activated.	24. • The Sepia or Monotone mode is activated.	24. • Turn off Sepia or Monotone before setting White Balance (☞ pg. 35, 37).
25. When shooting a subject illuminated by bright light, vertical lines appear.	25. • This is a result of exceedingly high contrast, and is not a malfunction.	25. _____
26. When the screen is under direct sunlight during shooting, the screen becomes red or black for an instant.	26. • This is not a malfunction.	26. _____
27. During recording, the date/time does not appear.	27. • "DATE/TIME" is set to "OFF" in the Menu Screen. • Interface Shooting is performed.	27. • Set "DATE/TIME" to "ON" in the Menu Screen (☞ pg. 29). • During Interface Shooting, the date/time does not appear (☞ pg. 17).
28. Images stored in the memory card cannot be deleted.	28. • Images stored in the memory card are protected.	28. • Remove protection from the images stored in the memory card and delete them (☞ pg. 44, 45).
29. The indicators and messages do not appear.	29. • "TIME CODE" is set to "OFF" in the Menu Screen.	29. • Set "TIME CODE" to "ON" in the Menu Screen (☞ pg. 29, 39).

SYMPTOM	POSSIBLE CAUSES	CORRECTIVE ACTION
<p>30. Images on the LCD monitor appear dark or whitish.</p>	<p>30.</p> <ul style="list-style-type: none"> • In places subject to low temperature, images become dark due to the characteristics of the LCD monitor. When this happens, the displayed colours differ from those that are actually recorded. This is not a defect of the camcorder. • When the LCD monitor's fluorescent light reaches the end of its service life, images on the LCD monitor become dark. Consult your nearest JVC dealer. 	<p>30.</p> <ul style="list-style-type: none"> • Adjust the brightness and angle of the LCD monitor (☞ pg. 16, 17).
<p>31. The rear of the LCD monitor is hot.</p>	<p>31.</p> <ul style="list-style-type: none"> • The light used to illuminate the LCD monitor causes it to become hot. 	<p>31.</p> <ul style="list-style-type: none"> • Close the LCD monitor to turn it off or set the Power Switch to "OFF", and let the unit cool down.
<p>32. The indicators and the image colour on the LCD monitor are not clear.</p>	<p>32.</p> <ul style="list-style-type: none"> • This may occur when the surface or the edge of the LCD monitor is pressed. 	<p>32.</p> <p>_____</p>
<p>33. The LCD monitor or viewfinder indications blink.</p>	<p>33.</p> <ul style="list-style-type: none"> • Certain Fade/Wipe effects, certain modes of Programme AE with special effects, "DIS" and other functions that cannot be used together are selected at the same time. 	<p>33.</p> <ul style="list-style-type: none"> • Re-read the sections covering Fade/Wipe effects, Programme AE with special effects and "DIS" (☞ pg. 28, 32 – 35).
<p>34. Coloured bright spots appear all over the LCD monitor or the viewfinder.</p>	<p>34.</p> <ul style="list-style-type: none"> • The LCD monitor and the viewfinder are made with high-precision technology. However, black spots or bright spots of light (red, green or blue) may appear constantly on the LCD monitor or the viewfinder. These spots are not recorded on the tape. This is not due to any defect of the unit. (Effective dots: more than 99.99 %) 	<p>34.</p> <p>_____</p>

CONTINUED ON NEXT PAGE

SYMPTOM	POSSIBLE CAUSES	CORRECTIVE ACTION
35. During recording, sound cannot be heard.	35. • The optional headphones are not connected to the headphone connector. • The sound volume of the headphone connector was not adjusted appropriately. The sound volume at this point is the same as the level it was adjusted to during playback.	35. • Connect the optional headphones to the headphone connector (☞ pg. 82, 83). • Adjust the sound volume during playback (☞ pg. 38).
36. Play, Rewind and Fast-Forward functions do not work.	36. • The Power Switch is set to "A" or "M". • The D.S.C. playback mode is engaged.	36. • Set the Power Switch to "PLAY" (☞ pg. 38). • Press MEMORY PLAY to disengage the D.S.C. playback mode (☞ pg. 42).
37. A memory card cannot be played back.	37. • The Power Switch is set to "A" or "M". • The D.S.C. playback mode is not engaged.	37. • Set the Power Switch to "PLAY" (☞ pg. 42). • Press MEMORY PLAY (☞ pg. 42).
38. The tape is moving, but there is no picture.	38. • Your TV has AV input terminals, but is not set to its VIDEO mode. • The cassette holder cover is open.	38. • Set the TV to the mode or channel appropriate for video playback (☞ pg. 52, 53). • Close the cassette holder cover (☞ pg. 10).
39. The LCD monitor image is distorted.	39. • During playback of the unrecorded portion, High-speed Search and still playback, LCD monitor indications appear distorted. This is not a defect.	39. _____
40. Images on the LCD monitor are jittery.	40. • The speaker volume is too great.	40. • Turn the speaker volume down (☞ pg. 38).
41. There is no playback picture on the connected TV.	41. • Since the analogue input mode is engaged, the camcorder is in the Record-Standby mode.	41. • Set "S/AV INPUT" to "OFF" in the Menu Screen (☞ pg. 39).
42. Blocks of noise appear during playback, or there is no playback picture and the screen becomes blue.	42. _____	42. • Clean the video heads with an optional cleaning cassette (☞ pg. 90).
43. The LCD monitor, the viewfinder and the lens have become dirty (ex. fingerprints).	43. _____	43. • Wipe them gently with soft cloth. Wiping strongly can cause damage (☞ pg. 80).

SYMPTOM	POSSIBLE CAUSES	CORRECTIVE ACTION
44. An unusual mark appears.	44. _____	44. • Check the section of the manual that explains LCD monitor/viewfinder indications (☞ pg. 84 – 88).
45. An error indication (E01 — E06) appears.	45. • A malfunction of some kind has occurred. In this case the camcorder's functions become unusable.	45. • Remove the power supply (battery pack, etc.) and wait a few minutes for the indication to clear. When it does, you can resume using the camcorder. If the indication remains even though you repeat the above two or three times, please consult your nearest JVC dealer.
46. The charger indicator on the AC Power Adapter/Charger does not light.	46. • The temperature of the battery is extremely high/low. • Charging is difficult in places subject to extremely high/low temperatures.	46. • To protect the battery, it is recommended to charge it in places with a temperature of 10°C to 35°C (☞ pg. 89).
47. Picture does not appear on the LCD monitor.	47. • The viewfinder is pulled out. • The LCD monitor's brightness setting is too dark.	47. • Push the viewfinder back in. • Adjust the brightness of the LCD monitor (☞ pg. 16). • If the monitor is tilted upward 180 degrees, open the monitor fully (☞ pg. 16).
48. When the image is printed from the printer, a black bar appears at the bottom of the screen.	48. • This is not a malfunction.	48. • By recording with "DIS" activated (☞ pg. 28) this can be avoided.
49. When the camcorder is connected via the DV connector, the camcorder does not operate.	49. • The DV cable was plugged/unplugged with power turned on.	49. • Turn the camcorder's power off and on again, then operate it.
50. During transport, the lens cover opens.	50. _____	50. • Do not subject the camcorder to shock or excessive vibration during transport. • Turn the camcorder on and off. The lens cover closes.
51. The memory card cannot be removed from the camcorder.	51. _____	51. • Push in the memory card a few more times (☞ pg. 11).

After Use

- 1 Turn off the camcorder.
- 2 Slide and hold **OPEN/EJECT** in the direction of the arrow, then pull the cassette holder cover open until it locks. The cassette holder opens automatically. Remove the cassette.
- 3 Press "PUSH HERE" to close the cassette holder.
 - Once the cassette holder is closed, it recedes automatically. Wait until it recedes completely before closing the cassette holder cover.
- 4 Slide **BATT. RELEASE** ① and remove the battery pack ②.

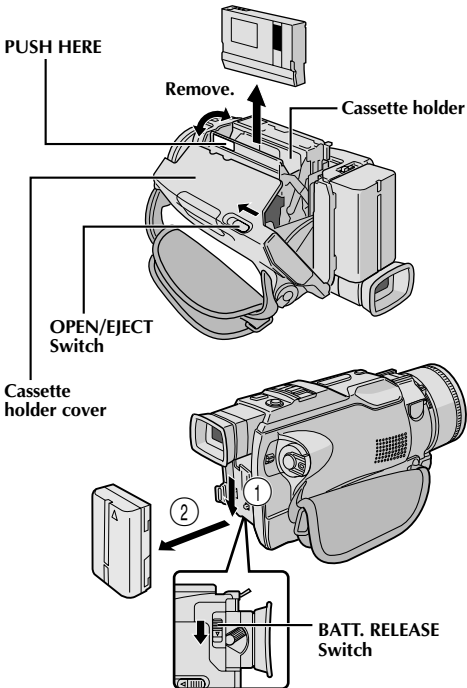

Cleaning The Camcorder

- 1 To clean the exterior, wipe gently with a soft cloth. Put the cloth in diluted mild soap and wring it well to wipe off heavy dirt. Then wipe again with a dry cloth.
- 2 Press **PUSH OPEN** and open the LCD monitor. Wipe gently with a soft cloth. Be careful not to damage the monitor. Close the LCD monitor.
- 3 To clean the lens, blow it with a blower brush, then wipe gently with lens cleaning paper.
- 4 To clean the viewfinder, raise it to the vertical position. Carefully lift the plastic tab on the bottom of the viewfinder, and open the hatch ①.
- 5 Insert a lens blower or soft cloth into the gap at the bottom of the viewfinder and clean the interior of the viewfinder with it ②.
- 6 Close the hatch. Tilt the viewfinder back to the horizontal position and push it back in.

NOTES:

- Avoid using strong cleaning agents such as benzine or alcohol.
- Cleaning should be done only after the battery pack has been removed or other power units have been disconnected.
- Mould may form if the lens is left dirty.
- When using a cleaner or chemically treated cloth refer to the cautions of each product.

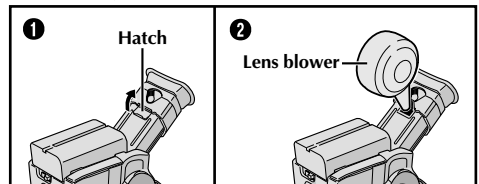
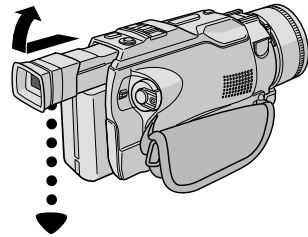

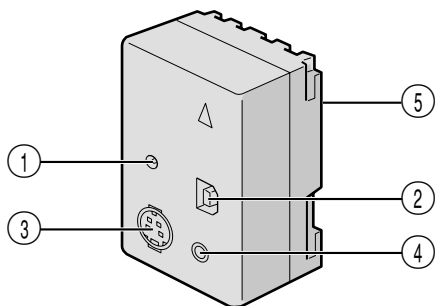





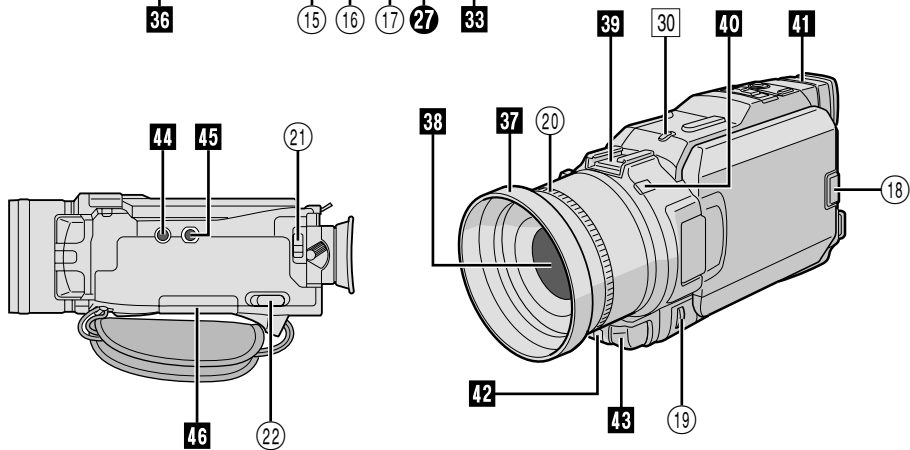
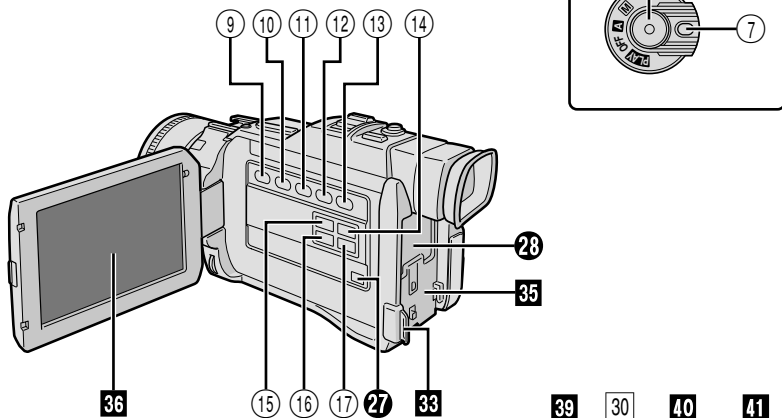
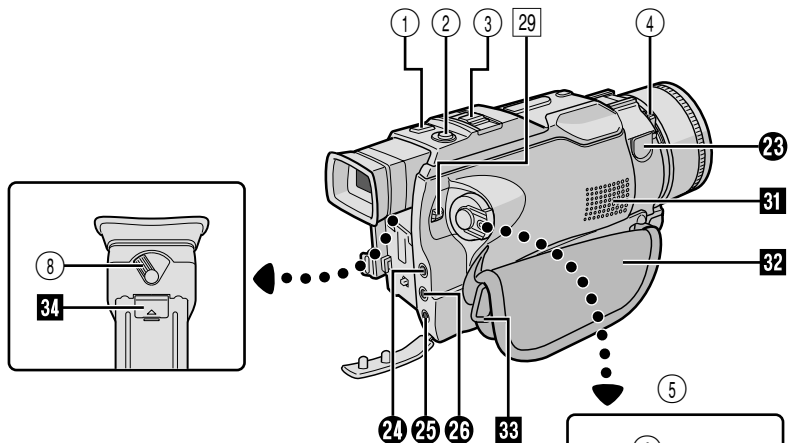





















- ① DC Input Connector [DC IN] pg. 7
- ② USB (Universal Serial Bus) Connector ... pg. 54
- ③ S-Video Input/Output Connector
[S-VIDEO] pg. 52, 53, 56, 57, 66
- ④ Edit Connector [EDIT] pg. 66
Connect the editing cable when performing
Random Assemble Editing pg. 65 – 70



- ⑤ Multi Connector
The Jack Box can be connected with this
camcorder through this connector. Never touch it
with your hand or hit it with a hard object; if the
pins are damaged, the connectors will become
unusable due to contact failure.





Controls



- ① FOCUS Button  pg. 25
- ② Snapshot Button
[SNAPSHOT]  pg. 18, 19, 22, 24, 60
- ③ • Power Zoom Lever [T/W]  pg. 20
• Speaker/Headphone Volume Control
[VOLUME]  pg. 38
- ④ Shooting Mode Switch
[VIDEO, XGA/VGA, UXGA]  pg. 12
- ⑤ Power Switch [A, M, PLAY, OFF]  pg. 12
- ⑥ Recording Start/Stop Button  pg. 16
- ⑦ Lock Button  pg. 12
- ⑧ Diopter Adjustment Control  pg. 8
- ⑨ MEMORY PLAY Button  pg. 42
- ⑩ • Stop Button [■]  pg. 38
• BACKLIGHT Button  pg. 36
- ⑪ • Rewind Button [◀◀]  pg. 38
• EXPOSURE Button  pg. 36
- ⑫ • Play/Pause Button [▶/||]  pg. 38
• Programme AE Button [PROG.AE]  pg. 34
- ⑬ • Fast-Forward Button [▶▶]  pg. 38
• FADE/WIPE Button  pg. 32
- ⑭ INDEX Button  pg. 43
- ⑮ BLANK SEARCH Button  pg. 41
- ⑯ PRINT FRAME Button  pg. 46
- ⑰ PRINT Button
Enables printing using the optional printer equipped with a PRINT DATA connector. Refer to the separate “FOR OWNERS OF AN OPTIONAL PRINTER” instruction sheet.
- ⑱ Monitor Open Button [PUSH OPEN] ...  pg. 16
- ⑲ • MENU Wheel [▲, ▼, PUSH]  pg. 26
• LCD Monitor Brightness Control  pg. 16
- ⑳ Manual Focus Ring  pg. 25
- ㉑ Battery Release Button
[BATT. RELEASE]  pg. 7
- ㉒ OPEN/EJECT Switch  pg. 10

Connectors













- ㉓ External Stereo Microphone Input Connector
[MIC]  pg. 71
The connectors ㉔ to ㉖ are located beneath a cover.
- ㉔ Headphone Connector [PHONE]  pg. 71
No sound is output from the speaker when headphones are connected to this connector.

- ㉕ PRINTER Connector
Connect to the optional printer equipped with a PRINT DATA connector. Refer to the separate “FOR OWNERS OF AN OPTIONAL PRINTER” instruction sheet.
- ㉖ Audio/Video Input/Output Connector
[AV]  pg. 52, 53, 56, 57, 66
- To connect a cable to the connector ㉗, open the LCD monitor.
- ㉗ Digital Video Connector
[DV IN/OUT] (i.Link*)  pg. 54, 55, 58, 59
* i.Link refers to the IEEE1394-1995 industry specification and extensions thereof. The  logo is used for products compliant with the i.Link standard.
- ㉘ Multi Connector
When attaching the Jack Box to the camcorder, this part is connected.

Indicators

- ㉙ Power Lamp  pg. 16
- ㉚ Tally Lamp  pg. 16

Other Parts

- ㉛ Speaker  pg. 38
- ㉜ Grip Strap  pg. 8
- ㉝ Shoulder Strap Eyelets  pg. 8
- ㉞ Viewfinder Cleaning Hatch  pg. 80
- ㉟ Battery Pack Mount  pg. 7
- ㊱ LCD Monitor  pg. 16, 17
- ㊲ Lens Hood  pg. 4
- ㊳ Lens Cover
Opens when the viewfinder is pulled out or the LCD monitor is opened fully.
- ㊴ Info-Shoe
Attach the optional video light/flash/zoom microphone.
- ㊵ Camera Sensor
Be careful not to cover this area, a sensor necessary for shooting is built-in here.
- ㊶ Viewfinder  pg. 8
- ㊷ Remote Sensor  pg. 61
- ㊸ Stereo Microphone  pg. 71
- ㊹ Stud Hole  pg. 8
- ㊺ Tripod Mounting Socket  pg. 8
- ㊻ MEMORY CARD Cover  pg. 11

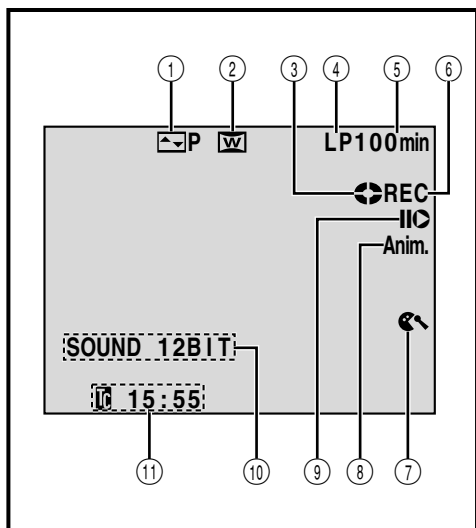

LCD Monitor/Viewfinder Indications During Video Recording Only

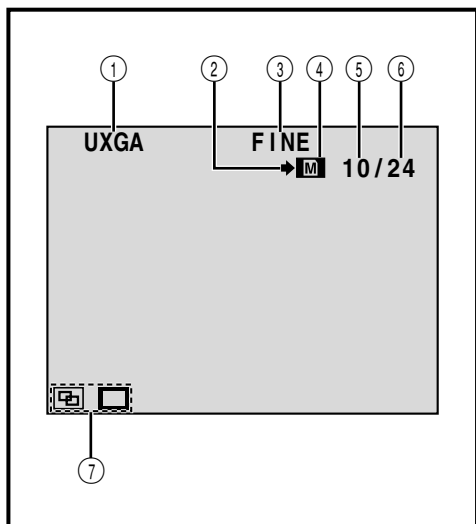

- ① Displays the selected Fade/Wipe effect. (☞ pg. 32, 33)
- ② Appears when in the Squeeze, Cinema or PS Wide mode. (☞ pg. 28)
- ③ Rotates while the tape is running. (☞ pg. 16)
- ④ Displays the recording mode (SP or LP). (☞ pg. 13)
- ⑤ Displays the tape remaining time. (☞ pg. 16)
- ⑥ • “REC” appears during recording.
• “PAUSE” appears during Record-Standby mode. (☞ pg. 16)
- ⑦ Appears when the wind cut mode is engaged to cut down on noise created by wind. (☞ pg. 28)
- ⑧ 5S/Anim.: Displays the 5 second recording mode or Animation recording mode. (☞ pg. 28, 31)
- ⑨ Appears when the Insert Editing (▶) or Insert Editing Pause (IIC) mode is engaged. (☞ pg. 72)
- ⑩ Displays the sound mode for approx. 5 seconds after turning on the camcorder. (☞ pg. 27)
- ⑪ Displays the Time Code. (☞ pg. 21, 29)

LCD Monitor/Viewfinder Indications During D.S.C. Recording Only



- ① Displays the file size of the stored image. There are 3 modes available: UXGA, XGA and VGA (in order of quality). (☞ pg. 14)
- ② Appears and blinks during shooting. (☞ pg. 19)
- ③ Displays the quality of the stored image. There are 2 modes available: FINE and STD (standard) (in order of quality). (☞ pg. 14)
- ④ • Appears during shooting.
• Blinks when a memory card is not loaded. (☞ pg. 19)
- ⑤ Displays the number of images that have already been shot. (☞ pg. 19)
- ⑥ Displays the total number of shots that can be stored, including those already taken. (☞ pg. 19)
- ⑦ Displays the UXGA mode:  (DOUBLE) or  (ENLARGE). (☞ pg. 14)

These indications also appear during DUAL mode.

LCD Monitor/Viewfinder Indications During Both Video And D.S.C. Recording

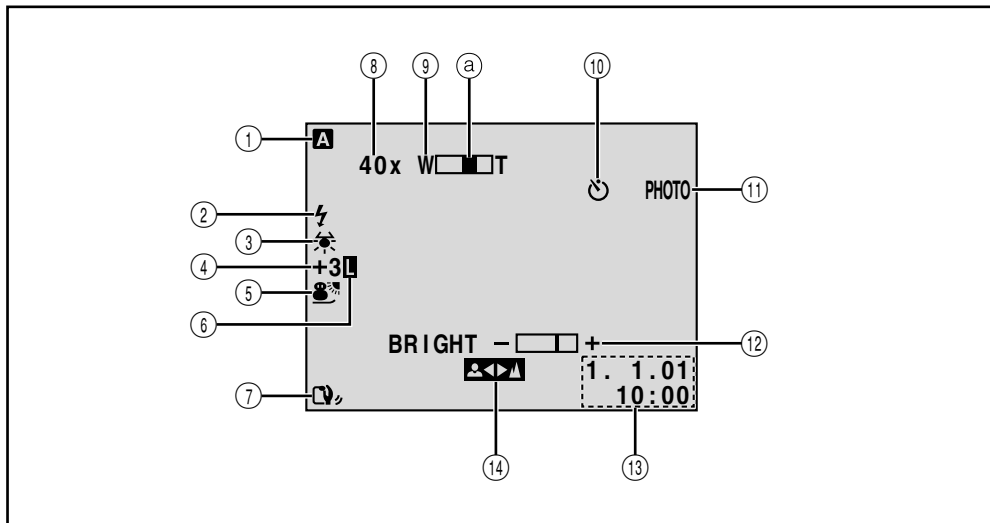

- ① Appears when the Power Switch is set to "A". (pg. 12)
- ② Appears when the optional flash attached to the info-shoe is ready.
- ③ Appears when the white balance is adjusted. (pg. 37)
- ④ • "±": Appears when the exposure is adjusted. (pg. 36)
 • : Appears when backlight compensation is used. (pg. 36)
- ⑤ Displays the selected Programme AE with special effects. (pg. 34)
- ⑥ Appears when the iris is locked. (pg. 36)
- ⑦ Appears when Digital Image Stabiliser ("DIS") is engaged. (pg. 27)
- ⑧ • Approximate zoom ratio: Appears during zooming. (pg. 20)
 • : Appears when "GAIN UP" is set to "AUTO" and the shutter speed is being automatically adjusted. (pg. 27)
- ⑨ Appears during zooming.
 ⓐ Zoom level indicator (pg. 20)
- ⑩ Appears during Self-Timer recording. (pg. 30)
- ⑪ Appears when taking a Snapshot. (pg. 18, 19)
- ⑫ Displays the brightness of the LCD monitor or the viewfinder. (pg. 16)
- ⑬ Displays the date/time. (pg. 9)
- ⑭ Appears when the focus is adjusted manually. (pg. 25)

LCD Monitor/Viewfinder Indications During Video Playback

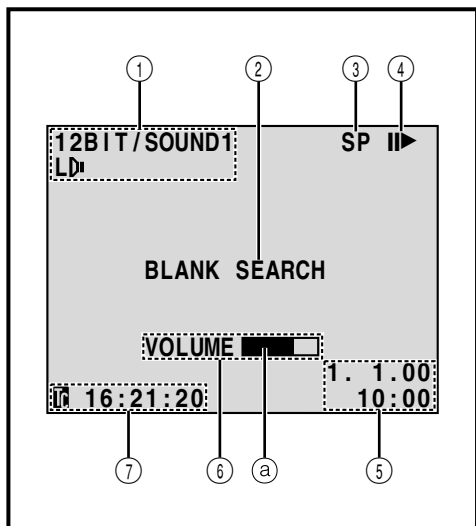





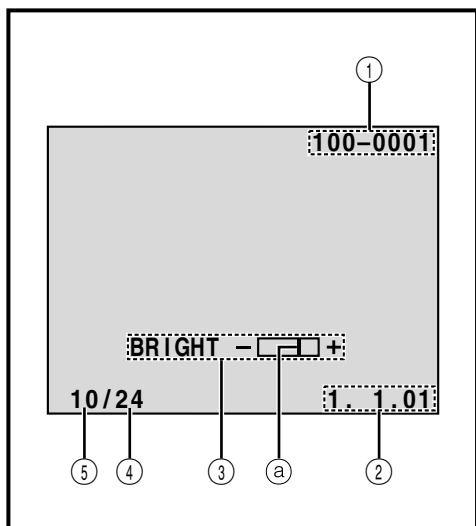





- ① Displays the sound mode. (☞ pg. 39, 40)
- ② Displays the Blank Search mode. (☞ pg. 41)
- ③ Displays the tape speed. (☞ pg. 13)
- ④ Appears while a tape is running.
 - ▶ : Playback
 - ▶▶ : Fast-Forward/Shuttle search
 - ◀◀ : Rewind/Shuttle search
 - || : Pause
 - ||▶ : Forward slow-motion
 - ◀|| : Reverse slow-motion
 - : Audio Dubbing
 - ||● : Audio Dubbing Pause
- ⑤ Displays the date/time. (☞ pg. 39, 40)
- ⑥ BRIGHT : Displays the brightness of the LCD monitor or the viewfinder. (☞ pg. 16)
VOLUME : Displays the speaker or headphone volume. (☞ pg. 38)
 - ⓐ The level indicator moves.
- ⑦ Displays the time code. (☞ pg. 39, 40)

LCD Monitor/Viewfinder Indications During D.S.C. Playback



- ① Displays the directory and file names. (☞ pg. 42)
- ② Displays the date. (☞ pg. 39, 40)
- ③ Displays the brightness of the LCD monitor or the viewfinder. (☞ pg. 16)
 - ⓐ The level indicator moves.
- ④ Displays the total number of stored files. (☞ pg. 42)
- ⑤ Displays the index number of the file. (☞ pg. 42)

Warning Indications

Indications	Function
	<p>Displays the battery remaining power.</p> <p>Remaining power level: high  →  →  → </p> <p>Remaining power level: exhausted </p> <p>As the battery power comes close to nil, the battery indicator  blinks. When the battery power is exhausted, power turns off automatically.</p>
	<p>Appears when no tape is loaded. (pg. 10)</p>
<p>CHECK TAPE'S ERASE PROTECTION TAB</p>	<p>Appears when the erase protection tab is set to "SAVE" while the Power Switch is set to "A" or "M". (pg. 10)</p>
<p> HEAD CLEANING REQUIRED USE CLEANING CASSETTE</p>	<p>Appears if dirt is detected on the heads during recording. Use an optional cleaning cassette. (pg. 90)</p>
<p> CONDENSATION OPERATION PAUSED PLEASE WAIT</p>	<p>Appears if condensation occurs. When this indication is displayed, wait more than 1 hour until condensation disappears.</p>
<p>TAPE!</p>	<p>Appears if a tape is not loaded when the Recording Start/Stop Button is pressed while the Power Switch is set to "A" or "M" and the Shooting Mode Switch is set to "VIDEO".</p>
<p>TAPE END</p>	<p>Appears when the tape ends during recording or playback. (pg. 17)</p>
<p>DIFFERENT FORMATTED TAPE</p>	<p>Appears if a tape in another format is loaded.</p>
<p>SET DATE/TIME!</p>	<ul style="list-style-type: none"> ● Appears when the date/time is not set. (pg. 9) ● Appears when the built-in clock (lithium) battery is discharged and the previously set date/time is erased. (pg. 9)
<p>A. DUB ERROR!</p>	<p>Appears if Audio Dubbing is attempted on a blank portion of a tape. (pg. 71)</p>
<p>A. DUB ERROR! <CANNOT DUB ON A LP RECORDED TAPE> <CANNOT DUB ON A 16BIT RECORDING> <CHECK TAPE'S ERASE PROTECTION TAB></p>	<ul style="list-style-type: none"> ● Appears if Audio Dubbing is attempted on a tape recorded in the LP mode. (pg. 71) ● Appears if Audio Dubbing is attempted on a tape recorded in 16-bit audio. (pg. 71) ● Appears if A. DUB (A) on the remote control is pressed when the erase protection tab is set to "SAVE". (pg. 71)
<p>INSERT ERROR!</p>	<p>Appears if Insert Editing is attempted on a blank portion of a tape. (pg. 72)</p>

Indications	Function
<p>INSERT ERROR! <CANNOT EDIT ON A LP RECORDED TAPE> <CHECK TAPE'S ERASE PROTECTION TAB> <CHECK SHOOTING MODE SWITCH></p>	<ul style="list-style-type: none"> ● Appears if Insert Editing is attempted on a tape recorded in the LP mode. (☞ pg. 72) ● Appears if INSERT (Ⓞ) on the remote control is pressed when the erase protection tab is set to "SAVE". (☞ pg. 72) ● Appears if the Shooting Mode Switch is set to "XGA/VGA" or "UXGA". (☞ pg. 14)
<p>MEMORY IS FULL</p>	<p>Appears when the memory card's memory is full and shooting is not possible.</p>
<p>COPYING FAILED</p>	<ul style="list-style-type: none"> ● Appears if dubbing of copyguarded signals is attempted while this camcorder is being used as a recorder. ● Appears in the following cases when dubbing from a tape to a memory card: <ul style="list-style-type: none"> – when no memory card is loaded. – when the memory card's memory is full. – when the memory card is not formatted. – when a copy-protected SD Memory Card is loaded. (☞ pg. 60)
<p>MEMORY CARD!</p>	<p>Appears in the following cases if a memory card is not loaded when SNAPSHOT is pressed:</p> <ul style="list-style-type: none"> – when the Power Switch is set to "A" or "M" and the Shooting Mode Switch is set to "XGA/VGA" or "UXGA". – when the Shooting Mode Switch is set to "VIDEO" and "CAMERA MODE" is set to "DUAL" in the Menu Screen. (☞ pg. 19, 24)
<p>PLEASE FORMAT</p>	<p>Appears when there is a problem with a memory card and its memory is corrupt, or it has not been initialised. Initialise the memory card. (☞ pg. 47)</p>
<p>NO IMAGES STORED</p>	<p>Appears if there is no images stored in the memory card when the Power Switch is set to "PLAY" and MEMORY PLAY is pressed.</p>
<p>CARD ERROR!</p>	<p>Appears when the camcorder takes more than 60 seconds to recognize the loaded memory card. Remove the memory card once and insert it again. Repeat these procedures until no indication appears. If the indication still appears, the memory card is corrupted.</p>
<p>CHECK CARD'S WRITE PROTECTION SWITCH</p>	<p>Appears when you attempt to shoot digital still images while a copy-protected SD Memory Card is loaded.</p>
<p>E01 — E06 UNIT IN SAFEGUARD MODE REMOVE AND REATTACH BATTERY</p>	<p>The error indications (E01 — E06) show what type of malfunction has occurred. When an error indication appears, the camcorder turns off automatically. Remove the power supply (battery, etc.) and wait a few minutes for the indication to clear. When it does, you can resume using the camcorder. If the indication remains, consult your nearest JVC dealer.</p>

General Battery Precautions

If the remote control is not functioning even if it is being operated correctly, the batteries are exhausted. Replace them with fresh ones.

Use only the following batteries: AAA (R03) size x 2
Please make note of the following rules for battery use. When misused, the batteries can leak or explode.

1. When replacing batteries, refer to page 61.
2. **Do not** use any different size of batteries from those specified.
3. Be sure to install batteries in the correct direction.
4. **Do not** use rechargeable batteries.
5. **Do not** expose the batteries to excessive heat as they can leak or explode.
6. **Do not** dispose of the batteries in a fire.
7. Remove the batteries from the unit if it is to be stored for an extended period to avoid battery leakage which can cause malfunctions.

Battery Packs

The supplied battery pack is a lithium-ion battery. Before using the supplied battery pack or an optional battery pack, be sure to read the following cautions:

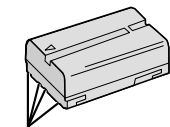

Terminals

1. To avoid hazards . . .

- **do not** burn.
- **do not** short-circuit the terminals. When transporting, make sure the provided battery cap is attached to the battery. If the battery cap is misplaced, carry the battery in a plastic bag.
- **do not** modify or disassemble.
- **do not** expose the battery to temperatures exceeding 60°C, as this may cause the battery to overheat, explode or catch fire.
- use only specified chargers.

2. To prevent damage and prolong service life . . .

- **do not** subject to unnecessary shock.
- charge in an environment where temperatures are within the tolerances shown in the chart below. This is a chemical reaction type battery—cooler temperatures impede chemical reaction, while warmer temperatures can prevent complete charging.

- store in a cool, dry place. Extended exposure to high temperatures will increase natural discharge and shorten service life.
- fully charge and then fully discharge the battery every 6 months when storing the battery pack over a long period time.
- remove from charger or powered unit when not in use, as some machines use current even when switched off.

NOTES:

- *It is normal for the battery pack to be warm after charging, or after use.*

Temperature Range Specifications

Charging 10°C to 35°C

Operation 0°C to 40°C

Storage -10°C to 30°C

- *Recharging time is based on room temperature of 20°C.*
- *The lower the temperature, the longer recharging takes.*

Cassettes

To properly use and store your cassettes, be sure to read the following cautions:

1. During use . . .

- make sure the cassette bears the Mini DV mark.
- be aware that recording onto prerecorded tapes automatically erases the previously recorded video and audio signals.
- make sure the cassette is positioned properly when inserting.
- do not load and unload the cassette repeatedly without allowing the tape to run at all. This slackens the tape and can result in damage.
- do not open the front tape cover. This exposes the tape to fingerprints and dust.

2. Store cassettes . . .

- away from heaters or other heat sources.
- out of direct sunlight.
- where they won't be subject to unnecessary shock or vibration.
- where they won't be exposed to strong magnetic fields (such as those generated by motors, transformers or magnets).
- vertically, in their original cases.

Memory Cards

To properly use and store your memory cards, be sure to read the following cautions:

- 1. During use . . .**
 - make sure the memory card bears the SD or MultiMediaCard mark.
 - make sure the memory card is positioned properly when inserting.
- 2. While the memory card is being accessed (during recording, playback, deletion, initialisation, etc.) . . .**
 - never unload the memory card and never turn off the camcorder.
- 3. Store memory cards . . .**
 - away from heaters or other heat sources.
 - out of direct sunlight.
 - where they won't be subject to unnecessary shock or vibration.
 - where they won't be exposed to strong magnetic fields (such as those generated by motors, transformers or magnets).

LCD Monitor

- 1. To prevent damage to the LCD monitor, DO NOT . . .**
 - push it strongly or apply any shocks.
 - place the camcorder with the LCD monitor on the bottom.
- 2. To prolong service life . . .**
 - avoid rubbing it with coarse cloth.
- 3. Be aware of the following phenomena for LCD monitor use.**
These are not malfunctions:
 - While using the camcorder, the surface around the LCD monitor and/or the back of the LCD monitor may heat up.
 - If you leave power on for a long time, the surface around the LCD monitor becomes hot.

Main Unit

- 1. For safety, DO NOT . . .**
 - open the camcorder's chassis.
 - disassemble or modify the unit.
 - short-circuit the terminals of the battery pack. Keep it away from metallic objects when not in use.
 - allow inflammables, water or metallic objects to enter the unit.
 - remove the battery pack or disconnect the power supply while the power is on.
 - leave the battery pack attached when the camcorder is not in use.
- 2. Avoid using the unit . . .**
 - in places subject to excessive humidity or dust.
 - in places subject to soot or steam such as near a cooking stove.
 - in places subject to excessive shock or vibration.
 - near a television set.
 - near appliances generating strong magnetic or electric fields (speakers, broadcasting antennas, etc.).
 - in places subject to extremely high (over 40°C) or extremely low (under 0°C) temperatures.
- 3. DO NOT leave the unit . . .**
 - in places of over 50°C.
 - in places where humidity is extremely low (below 35%) or extremely high (above 80%).
 - in direct sunlight.
 - in a closed car in summer.
 - near a heater.
- 4. To protect the unit, DO NOT . . .**
 - allow it to become wet.
 - drop the unit or strike it against hard objects.
 - subject it to shock or excessive vibration during transportation.
 - keep the lens directed at extremely bright objects for long periods.
 - expose the lens to direct sunlight.
 - carry it by holding the LCD monitor or the viewfinder.
 - swing it excessively when using the shoulder strap or the grip.

5. Dirty heads can cause the following problems:

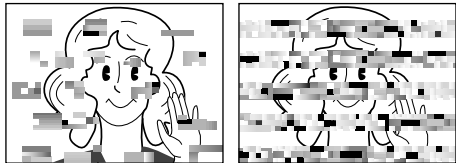

- No picture during playback.
- Blocks of noise appear during playback.
- During recording, the Head Clog Warning indicator “” appears.

In such cases, use an optional cleaning cassette. Insert it and play back. If the cassette is used more than once consecutively, damage to the video heads may result. After the camcorder plays back for about 20 seconds, it stops automatically. Also refer to the cleaning cassette's instructions.

If, after using the cleaning cassette, the problems still exist, consult your nearest JVC dealer. Mechanical moving parts used to move the video heads and video tape tend to become dirty and worn out over time. In order to maintain a clear picture at all times, periodic check-ups are recommended after using the unit for about 1,000 hours. For periodic check-ups please consult your nearest JVC dealer.

How To Handle A CD-ROM

- Take care not to soil or scratch the mirror surface (opposite to the printed surface). Do not write anything or put a sticker on either the front or back surface. If the CD-ROM gets dirty, gently wipe it with a soft cloth outward from the centre hole using a circular motion.
- Do not use conventional disc cleaners or cleaning spray.
- Do not bend the CD-ROM or touch its mirror surface.
- Do not store your CD-ROM in a dusty, hot or humid environment. Keep it away from direct sunlight.

About moisture condensation . . .

- You have observed that pouring a cold liquid into a glass will cause drops of water to form on the glass' outer surface. This same phenomenon occurs on the head drum of a camcorder when it is moved from a cool place to a warm place, after heating a cold room, under extremely humid conditions or in a place directly subjected to the cool air from an air conditioner.
- Moisture on the head drum can cause severe damage to the video tape, and can lead to internal damage to the camcorder itself.

Serious malfunctioning

If malfunctioning occurs, stop using the unit immediately and consult your local JVC dealer.

The camcorder is a microcomputer-controlled device. External noise and interference (from a TV, a radio, etc.) might prevent it from functioning properly. In such cases, first disconnect its power supply unit (battery pack, AC Power Adapter/Battery Charger, etc.) and wait a few minutes and then re-connect it and proceed as usual from the beginning.

A

- AC Power Adapter/Charger pg. 6, 7
- Analogue Input pg. 39, 57
- Animation pg. 28
- Audio Dubbing pg. 71
- Auto Date pg. 29
- Auto Focus pg. 25
- Auto Playback pg. 42
- Auto Shut off pg. 17, 19, 38

B

- Backlight Compensation pg. 36
- Battery Low pg. 87
- Battery Pack pg. 6, 7, 89
- Beep pg. 29
- Brighten The LCD Monitor pg. 16
- Built-in Clock's Lithium Battery pg. 9

C

- Channels (Left/Right) pg. 40
- Charge The Battery Pack pg. 6
- Cinema pg. 28
- Classic Film pg. 35
- Clean The Camcorder pg. 80
- Connections pg. 7, 52, 54 – 59, 66

D

- Darken The LCD Monitor pg. 16
- Date/Time Display pg. 29, 39, 40
- Date/Time Settings pg. 9
- Deleting Images pg. 45
- Demonstration Mode pg. 5, 29
- Digital Zoom pg. 20, 27
- DIS (Digital Image Stabiliser) pg. 28
- Dioptré Adjustment pg. 8
- DPOF (Digital Print Order Format) pg. 50
- Dual Shooting pg. 24
- Dubbing pg. 56 – 60

E

- Erase Protection pg. 10
- Exposure Control pg. 36

F

- Fade-In/Out pg. 32, 33
- Fast-Forward The Tape pg. 38
- 5-second recording mode pg. 31
- Frame-By-Frame Playback pg. 38, 63

G

- Gain Up pg. 27
- Grip Adjustment pg. 8

I

- Icons pg. 27 – 29
- Index Playback pg. 43
- Index Screen pg. 43
- Initialise A Memory Card pg. 47
- Insert Editing pg. 72
- Interface Shooting pg. 17
- Iris pg. 36
- Iris Lock pg. 36

J

- Journalistic Shooting pg. 17

L

- LCD monitor/Viewfinder
 - Indications pg. 84 – 88
- Load A Tape pg. 10

M

- Manual Focus pg. 25
- Memory Card pg. 11, 90
- Menu Screen, CAMERA pg. 27
- Menu Screen, DISPLAY pg. 29, 39
- Menu Screen, DSC pg. 14
- Menu Screen, MANUAL pg. 27, 28
- Menu Screen, MEMORY pg. 44
- Menu Screen, SYSTEM pg. 29, 39
- Menu Screen, VIDEO pg. 39
- Monotone pg. 35
- Motor Drive Mode pg. 18
- MultiMediaCard pg. 11, 90

P

Picture Mode	☞ pg. 14
Picture Wipe/Dissolve	☞ pg. 32, 33
Playback Special Effects	☞ pg. 64
Playback Zoom	☞ pg. 63
Power Switch Position	☞ pg. 12
Print Frame Deletion	☞ pg. 48, 49
Printer	☞ pg. 55
Programme AE With Special Effects	☞ pg. 34, 35
Progressive Mode	☞ pg. 22, 23
Progressive Wide	☞ pg. 28
Protecting Images	☞ pg. 44
Provided Accessories	☞ pg. 4

R

Random Assemble Editing	☞ pg. 65 – 70
Record-Standby	☞ pg. 16
Recording Mode	☞ pg. 13
Remote Control	☞ pg. 61
Rewind The Tape	☞ pg. 38

S

SD Memory Card	☞ pg. 11, 90
Self-Recording	☞ pg. 17
Self-Timer	☞ pg. 30
Sepia	☞ pg. 35
Set Remote Control/VCR Code	☞ pg. 65
Shooting Mode, XGA/VGA	☞ pg. 12
Shooting Mode, UXGA	☞ pg. 12
Shooting Mode Switch Position	☞ pg. 12
Shuttle Search	☞ pg. 38
Shutter Speed	☞ pg. 35
Slow-Motion Playback	☞ pg. 38, 63
Slow Shutter	☞ pg. 35
Snapshot	☞ pg. 18, 19, 24
Snapshot Mode	☞ pg. 18
Snow	☞ pg. 35
Sound Mode	☞ pg. 27, 39, 40
Speaker Volume	☞ pg. 38
Specifications	☞ pg. 94, 95
Sports	☞ pg. 35
Spotlight	☞ pg. 35
Squeeze	☞ pg. 28
Still Playback	☞ pg. 38
Strobe	☞ pg. 35
Superimposing A Print Frame	☞ pg. 46

T

Tally	☞ pg. 29
Tele Macro	☞ pg. 28
Time Code	☞ pg. 21, 29, 39, 40
Tripod Mounting	☞ pg. 8
Twilight	☞ pg. 35

U

Unload A Tape	☞ pg. 10
---------------------	----------

V

Video Echo	☞ pg. 35
------------------	----------

W



White Balance	☞ pg. 37
Wide Mode	☞ pg. 28
Wind Cut	☞ pg. 28
Wipe In/Out	☞ pg. 32, 33

Z

Zooming	☞ pg. 20
---------------	----------

Camcorder

For General

Power supply	: DC 6.3 V  (Using AC Power Adapter/Charger) DC 7.2 V  (Using battery pack)
Power consumption	
LCD monitor off, viewfinder on	: Approx. 4.4 W
LCD monitor on, viewfinder off	: Approx. 5.3 W
Dimensions (W x H x D)	: 74 mm x 90 mm x 178 mm (with the LCD monitor closed and the viewfinder pushed back in, without the lens hood)
Weight	: Approx. 660 g (without cassette, memory card and battery) Approx. 740 g (incl. cassette, memory card and battery)
Operating temperature	: 0°C to 40°C
Operating humidity	: 35% to 80%
Storage temperature	: -20°C to 50°C
Pickup	: 1/4" CCD (Progressive Scan)
Lens	: F 1.8, f = 3.8 mm to 38 mm, 10:1 power zoom lens
Filter diameter	: ø52 mm
LCD monitor	: 3.5" diagonally measured, LCD panel/TFT active matrix system
Viewfinder	: Electronic viewfinder with 0.44" colour LCD
Speaker	: Monaural

For Digital Video Camera

Format	: DV format (SD mode)
Signal format	: PAL standard
Recording/Playback format	: Video: Digital component recording Audio: PCM digital recording, 32 kHz 4-channel (12-bit), 48 kHz 2-channel (16-bit)
Cassette	: Mini DV cassette
Tape speed	: SP: 18.8 mm/s LP: 12.5 mm/s
Maximum recording time (using 80 min. cassette)	: SP: 80 min. LP: 120 min.

For Digital Still Camera

Storage media	: SD Memory Card/MultiMediaCard
Compression system	: JPEG (compatible)
File size	: 3 modes (UXGA: 1600 x 1200 pixels/XGA: 1024 x 768 pixels/ VGA: 640 x 480 pixels)
Picture quality	: 2 modes (FINE/STANDARD)
Approximate number of storable images (with 16 MB MultiMediaCard)	
FINE	: 100 (VGA), 48 (XGA), 20 (UXGA)
STANDARD	: 300 (VGA), 144 (XGA), 60 (UXGA)
(with 8 MB MultiMediaCard)	
FINE	: 50 (VGA), 24 (XGA), 10 (UXGA)
STANDARD	: 150 (VGA), 72 (XGA), 30 (UXGA)

For Connectors

AV

Video output	: 1 V (p-p), 75 Ω , analogue
Video input	: 0.5 V (p-p) – 2.0 V (p-p), 75 Ω , analogue
Audio output	: 308 mV (rms), 1 k Ω , analogue, stereo
Audio input	: 308 mV (rms), 50 k Ω , analogue, stereo

DV

Output	: 4-pin, IEEE 1394 compliant
Input	: 4-pin, IEEE 1394 compliant

PHONE

Headphone output	: \varnothing 3.5 mm, stereo
------------------	--------------------------------

MIC

External microphone input	: 459 μ V (rms), high impedance unbalanced, \varnothing 3.5 mm (stereo)
---------------------------	---

PRINTER

	: For an optional video printer equipped with a PRINT DATA connector
--	--

AC Power Adapter/Charger AA-V40EA, AA-V40A, AA-V40A-S, AA-V40SH or AA-V40ED

Power requirement	: AC 110 V to 240 V \sim , 50 Hz/60 Hz
-------------------	--

Power consumption	: 23 W
-------------------	--------

Output

Charge	: DC 7.2 V $\overline{\text{---}}$, 1.2 A
--------	--

VTR	: DC 6.3 V $\overline{\text{---}}$, 1.8 A
-----	--

Dimensions (W x H x D)	: 68 mm x 38 mm x 110 mm
------------------------	--------------------------

Weight

AA-V40EA	: Approx. 270 g
----------	-----------------

AA-V40A/A-S/SH/ED	: Approx. 260 g
-------------------	-----------------

Jack Box CU-V504U

For General

Dimensions (W x H x D)	: 37.5 mm x 18.5 mm x 55 mm
------------------------	-----------------------------

Weight	: Approx. 30 g
--------	----------------

For Connectors

USB	: TYPE B
-----	----------

S-VIDEO	: Y: 1 V (p-p), 75 Ω , analogue output C: 0.29 V (p-p), 75 Ω , analogue output
---------	---

EDIT	: \varnothing 3.5 mm, 2-pole
------	--------------------------------

Specifications shown are for SP mode unless otherwise indicated. E & O.E. Design and specifications subject to change without notice.

